

Product Catalog

Manhattan and Intellinet Network Solutions
January - March 2014
manhattan-products.com • intellinet-network.com



ICG-EN

Shown:
Lyric Duo
(161367)



Networking Just Got **Easier With...**



Wireless Routers

Wireless Adapters



USB Adapters

Powerline



Switches

Find all your wireless and networking solutions at
manhattan-products.com

© IC Intracom. All rights reserved. Manhattan and Intellinet Network Solutions are globally registered trademarks of IC Intracom. Other trademarks and trade names are the property of their respective owners. Some product images are simulated, actual appearance may vary. Distribution or reproduction of this document and use or disclosure of the contents herein are prohibited, unless specifically authorized.

Lifetime Warranty: Most Manhattan and Intellinet Network Solutions products are warranted against defects in material and workmanship for as long as they are owned by the original purchaser. See your local dealer for repair or replacement.

Copyright © 2014

Active Networking

	Page
Access Points.....	2-3
Adapters	4
Antennas	5-6
Internet Access.....	21
KVM.....	12
Media Converters.....	13
Network Adapters.....	12
Network Cameras	14-15
Network Storage.....	15
PCI Cards.....	4
Power-Over-Ethernet	10-11
Routers	2-3
Switches, Fast Ethernet.....	7-8
Switches, Gigabit.....	8-9
Switches, SFP Tranceivers.....	13

Passive Networking

Cables, Bulk	18
Cables, Cat5e Patch.....	16
Cables, Cat6 Patch.....	16-17
Inline Couplers	20
Patch Panels.....	19
RJ-45 Components.....	20
Testers.....	21
Tools	21

Manhattan Networking

Networking.....	22-26
-----------------	-------

Computer Components

Audio/Video.....	32-33
Barcode Scanners	41-42
Cards	52-54
Card Readers	48-49
CPU Thermal Grease	50
External Enclosures.....	51
Headphones.....	34-37

Computer Components

	Page
Headsets.....	34-37
Keyboards.....	29-30
KVM Switches	55
Mice	27-28
Quick Docks	50
Speakers	38-40
USB Hubs.....	43-45
USB Peripherals	46-48
Webcams.....	31

Cables and Data Communications

Audio/Video Cables.....	64
DisplayPort Cables.....	61
DVI Cables.....	62
Firewire Cables	63
HDMI Cables.....	58-59
iPod/iPhone/iPad Cables.....	64
Mini-DisplayPort Cables	61-62
Network Cables.....	64
Power Cables	63
SATA Cables	62-63
USB Cables	56-57
VGA Cables.....	59-60

Mobile Computing

Cleaning Products	75
Display Systems	81-83
External Coolers	67
Mouse Pads.....	77
Notebook Accessories	69
Notebook Cases	65-66
Power Adapters	68
Tablet Accessories.....	78-80
Television, Projector and Monitor Mounts.....	70-74
Tool Kits	76

[1] Wireless 150N Access Point

- Supports Wi-Fi Protected Setup (WPS)
- Supports WEP and WPA/WPA2 (TKIP and AES) data encryption
- Integrated RADIUS authentication server for 16 wireless clients
- Supported modes: Access Point, Bridge Point-to-Point, Bridge Point-to-Multi-Point, WDS and Universal Repeater

Model Number: 524704



[2] Wireless 150N ADSL2+ Modem Router

- Wireless N router with integrated ADSL2+ modem
- Supports WEP and WPA/WPA2 (TKIP and AES) data encryption
- Ideal for streaming HD-quality video, playing online games, downloading large files and making VoIP calls

Model Number: 525299



[3] Wireless 300N Access Point

- Supports Wi-Fi Protected Setup (WPS)
- Supports WEP and WPA/WPA2 (TKIP and AES) data encryption
- Integrated RADIUS authentication server for 16 wireless clients
- Supported modes: Access Point, Bridge Point-to-Point, Bridge Point-to-Multi-Point, WDS and Universal Repeater

Model Number: 524728



[4] Wireless 300N PoE Access Point

- Supports Wi-Fi Protected Setup (WPS)
- Supports WEP and WPA/WPA2 (TKIP and AES) data encryption
- Integrated RADIUS authentication server for 16 wireless clients
- Supported modes: Access Point, Bridge Point-to-Point, Bridge Point-to-Multi-Point, WDS and Universal Repeater

Model Number: 524735



[5] High-Power Ceiling Mount Wireless 300N PoE Access Point

- Super long-range indoor Wireless N range extender and universal repeater
- Supports Wi-Fi Protected Setup (WPS)
- Supported modes: Access Point, Bridge Point-to-Point, Bridge Point-to-Multi-Point, WDS and Universal Repeater

Model Number: 525251



[6] Wireless 150N Outdoor Range Extender/Access Point

- Up to 150 Mbps network link speed
- Provides a Wi-Fi coverage range of up to 1 kilometer (1,100 yards)
- Supports Wi-Fi Protected Setup (WPS)
- IPX-5 water-resistant
- Supported modes: Access Point, Bridge Point-to-Point, Bridge Point-to-Multi-Point, WDS and Universal Repeater

Model Number: 525497





[7] Wireless 300N Outdoor PoE Access Point

- Industrial-grade IP 67 housing for optimal protection against dust and water
- Supports WEP and WPA/WPA2 (TKIP and AES) data encryption
- Integrated RADIUS authentication server for 16 wireless clients
- Supported modes: Access Point, Bridge Point-to-Point, Bridge Point-to-Multi-Point, WDS and Universal Repeater

Model Number: 524711



[8] Wireless 300N Dual-Band Router

- Supports simultaneous dual-band 2.4 GHz and 5 GHz operation
- Up to 300 Mbps network link speed
- Supports WEP and WPA/WPA2 (TKIP and AES) data encryption
- Supported modes: Access Point, Station Infrastructure, Bridge Point-to-Point, Bridge Point-to-Multi-Point, WDS and Universal Repeater

Model Number: 525268



[9] Wireless 450N Dual-Band Gigabit Router

- Supports simultaneous dual-band 2.4 GHz and 5 GHz operation
- Up to 450 Mbps network link speed
- Supports WEP and WPA/WPA2 (TKIP and AES) data encryption
- Supported modes: Access Point, Station Infrastructure, Bridge Point-to-Point, Bridge Point-to-Multi-Point, WDS and Universal Repeater

Model Number: 524988



[10] GuestGate MK II

- Captive portal provides instant secure guest access to the public network
- The ideal solution for conference rooms, Internet cafés and hotels
- All-in-one wireless high-speed HotSpot for secure access to the Internet

Model Number: 524827

[1] Wireless 150N USB Adapter

- Includes detachable 3 dBi high-gain antenna with reverse SMA connector
- High transfer data rate – up to 150 Mbps
- Supports WEP (64/128 bit), WPA and WPA2 data encryption

Model Number: 524698



[2] Wireless 300N USB Adapter

- Up to 300 Mbps network link speed
- Advanced 2T2R MIMO technology with 2 internal antennas for enhanced throughput and coverage
- Supports WEP (64/128 bit), WPA and WPA2 data encryption

Model Number: 523974



[3] Wireless 300N High-Gain USB Adapter

- Up to 300 Mbps network link speed
- Supports Wi-Fi Protected Setup (WPS)
- Supports WEP (64/128 bit), WPA and WPA2 data encryption

Model Number: 525206



[4] Wireless 300N PCI Card

- Connects your desktop PC to a wireless network
- Two detachable 3 dBi antennas with reverse SMA connector
- Supports WMM (Wi-Fi Multimedia) for increased multimedia data throughput

Model Number: 525176



[5] Wireless 300N Dual-Band USB Adapter

- Dual-band operation provides twice the bandwidth and less interference
- Advanced 2T2R MIMO technology with 2 internal antennas for enhanced throughput and coverage
- Supports WEP (64/128 bit), WPA and WPA2 data encryption

Model Number: 524995



[6] Wireless 450N Dual-Band USB Adapter

- Dual-band operation provides twice the bandwidth and less interference
- Supports advanced 3T3R MIMO technology, enhancing the throughput and coverage range significantly
- Supports WEP (64/128 bit), WPA and WPA2 data encryption

Model Number: 525275





7

180 x 200 mm



2

360 x 220 mm

3



260 x 260 mm



580 mm long

4

521413



6

201 mm tall



5

302 mm tall

[1] High-Gain MIMO Panel Directional Antenna

- Ideal for wireless access points and bridges with two antenna connectors
- Connection to Intellinet Wireless 300N Access Points (524728 and 524735) requires two antenna cables, model 790406
- Not suitable for use with Intellinet Wireless 300N Outdoor PoE Access Point 524711

Model Number: 790338 2T2R MIMO, 2.4 GHz, 12 dBi, IP65

[2] High-Gain Panel Directional Antenna

- Ideal for building-to-building wireless connections
- Weatherproof and corrosion resistant, IP68
- N-type female connector

Model Number: 502313 2.4 GHz, 18 dBi, IP68

[3] High-Gain Panel Directional Antenna

- Ideal for building-to-building wireless connections
- Weatherproof and corrosion resistant, IP68
- N-type female connector

Model Number: 500449 2.4 GHz, 15 dBi, IP68

[4] High-Gain Omni-Directional Antenna

- Ideal for increasing wireless network range and speed
- Weatherproof and corrosion resistant, IP65
- N-type female connector

Model Number: 521413 2.4 GHz, 9 dBi, IP65
 Model Number: 502306 2.4 GHz, 12 dBi, IP65

[5] Indoor Omni-Directional Antenna

- RP-SMA male connector
- Including antenna cable (1.5 m / 5 ft.)
- Heavy base with rubber feet for stable desktop installation

Model Number: 524018 2.4 GHz, 7 dBi

[6] Indoor Omni-Directional Antenna

- Ideal for increasing wireless network range and speed
- For desktop, wall and magnet mounting
- RP-SMA male connector

Model Number: 502290 2.4 GHz, 5 dBi

[7] Dual-Band Ceiling Mount Antenna

- Provides uniform coverage in conference rooms, offices and common areas
- For indoor use with common wireless access points and routers
- 30 cm (1 ft.) connection cable with RP-SMA female connector

Model Number: 524025 2.4 / 5.0 GHz, 4 dBi, IP65



130 x 125 mm

[8] Antenna Cable

- Signal loss of 0.21 dB per ft.
- SMA plug to RP-SMA plug

Model Number: 790406 3,0 m



[9] Antenna Cable

- Signal loss of 0.25 dB per ft
- N-type Male/RP-SMA Male connectors

Model Number: 522137 1,8 m

Model Number: 522144 3 m

Model Number: 522175 7,5 m



[10] Low-Loss Antenna Cable

- Low signal loss of only 0.09 dB per ft
- Ideal for longer cable runs
- N-type Male/Male connectors

Model Number: 790291 7,5 m



[11] Ultra-Low-Loss CFD600 Antenna Cable

- Extremely low signal loss of only 0.04 dB per ft.
- Ideal for longer cable runs
- N-type Male/Male connectors

Model Number: 500395 15 m



[12] Antenna Cable Adapter

- Connects CFD200, CFD400 and CFD600 cable to regular WLAN Access Points and Routers

Model Number: 500425 30 cm





[1] 5-Port Fast Ethernet Office Switch

- Five 10/100 auto-sensing ports - automatically detect optimal network speeds
- Supports any combination of 10 Mbps or 100 Mbps network devices
- NWay auto-negotiation

Model Number: 502023 *Plastic*



[2] 5-Port Fast Ethernet Office Switch

- Five 10/100 auto-sensing ports - automatically detect optimal network speeds
- Supports any combination of 10 Mbps or 100 Mbps network devices
- Supports NWay auto-negotiation

Model Number: 523301 *Metal*



[3] 8-Port Fast Ethernet Office Switch

- Eight 10/100 auto sensing ports - automatically detect optimal network speeds
- Supports any combination of 10 Mbps or 100 Mbps network devices
- Supports NWay auto-negotiation

Model Number: 523318 *Metal*



[4] 16-Port Fast Ethernet Office Switch

- 10/100 auto sensing ports - automatically detect optimal network speeds
- Supports any combination of 10 Mbps or 100 Mbps network devices
- Supports NWay Auto-Negotiation

Model Number: 522595 *Metal*



[5] 16-Port Fast Ethernet Rackmount Switch

- 10/100 auto-sensing ports automatically detect optimal network speeds
- Supports NWay auto-negotiation
- 19" compact rigid metal case

Model Number: 520409 *Metal*

[6] 24-Port Fast Ethernet Rackmount Switch

- 10/100 auto-sensing ports automatically detect optimal network speeds
- Supports NWay auto-negotiation
- 19" compact rigid metal case

Model Number: 520416 *Metal*



[7] 24-Port Fast Ethernet Office Switch

- 24 10/100 Mbps auto-sensing Auto-MDIX RJ-45 ports
- 2 Gigabit (RJ-45 + SFP) combo ports
- Supports NWay auto-negotiation
- Includes 19" rackmount brackets

Model Number: 523929 *Metal*



[8] 5-Port Gigabit Ethernet Switch

- 10/100/1000 auto-sensing Auto MDI-X ports — automatically detect optimal network speeds
- Green Ethernet power-saving technology deactivates unused ports and adjusts power levels based on the cable length
- Supports jumbo frames up to 9 kBytes

Model Number: 524117 *Plastic*



[9] 8-Port Gigabit Ethernet Switch

- 10/100/1000 auto-sensing Auto MDI-X ports — automatically detect optimal network speeds
- High performance, half and full duplex, with zero packet loss
- Supports jumbo frames up to 9 kBytes

Model Number: 524124 *Plastic*



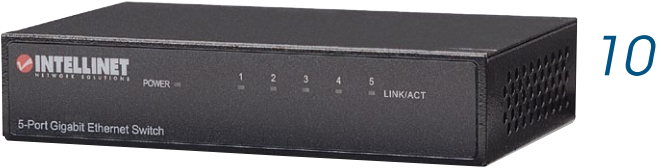

10

[10] 5-Port Gigabit Ethernet Switch

- 10/100/1000 auto-sensing Auto MDI-X ports — automatically detect optimal network speeds
- High performance, half and full duplex, with zero packet loss
- Supports jumbo frames up to 9 kBytes

Model Number: 530378 *Metal*



11

[11] 8-Port Gigabit Ethernet Switch

- 10/100/1000 auto-sensing Auto MDI-X ports — automatically detect optimal network speeds
- High performance, half and full duplex, with zero packet loss
- Supports jumbo frames up to 9 kBytes

Model Number: 530347 *Metal*



12

[12] 16-Port Gigabit Ethernet Rackmount Switch

- 10/100/1000 auto-sensing ports automatically detect optimal network speeds
- Supports 802.3x flow control for full duplex mode and collision-based backpressure for half duplex mode

Model Number: 524148 *Metal*



13

[13] 24-Port Gigabit Ethernet Rackmount Switch

- 10/100/1000 auto-sensing ports automatically detect optimal network speeds
- Supports 802.3x flow control for full duplex mode and collision-based backpressure for half duplex mode

Model Number: 524162 *Metal*



14

[14] Web-Managed Gigabit Ethernet Switch with 4 SFP Ports

- 10/100/1000 Mbps auto-sensing ports automatically detect optimal network speeds
- Four small form-factor pluggable GBIC module slots (SFP)

Model Number: 560801 *16-Port, Metal*
 Model Number: 560818 *24-Port, Metal*

[1] Power over Ethernet (PoE) Injector

- Ideal when AC power is not available
- Power output of up to 15.4 Watts
- Supports all IEEE 802.3af-compliant PoE devices (Wireless LAN access points and bridges, VoIP (Voice over Internet Protocol) telephones, IP surveillance cameras)

Model Number: 524179



[2] 1-Port Gigabit High-Power PoE+ Injector

- Save time and money by delivering data and power via existing network cables
- Power output of up to 30 Watts
- Supports all IEEE 802.3at- and IEEE 802.3af-compliant PoE devices (Wireless LAN access points and bridges, VoIP [Voice over Internet Protocol] telephones, IP surveillance cameras)

Model Number: 560566



[3] Power over Ethernet (PoE) Splitter

- Can be used to connect non-PoE IEEE 802.3af-compliant devices to a PoE injector or PoE switch
- Output current, selectable: 5, 7.5, 9 or 12 V DC

Model Number: 502900

IEEE802.3af, max. 15.4 W

Model Number: 560443

IEEE802.3at, max. 30 W



[4] 8-Port PoE+ Desktop Switch

- Provides power and data connection for PoE network devices
- 10/100 auto-sensing ports automatically detect optimal network speeds

Model Number: 560764

8 x PoE ports

Model Number: 560757

4 x PoE ports,

4 x Standard RJ45 Ports



[5] 8-Port PoE+ Web-Smart Switch

- Provides power and data connection for up to eight PoE network devices
- 10/100 auto-sensing ports automatically detect optimal network speeds
- Total power budget of 130 Watts

Model Number: 560665





6

[6] 8-Port Rackmount PoE Midspan

- 8 RJ45 input ports with NWay support
- 8 IEEE 802.3af-compliant RJ45 PSE/PoE output ports for signal and data
- Power output up to 15.4 Watts per port

Model Number: 502931



7

[7] 16-Port Fast Ethernet PoE+ Switch

- IEEE 802.3at/af-compliant RJ45 PoE/PoE+ output ports
- 8 integrated PoE ports (Ports 9 to 16) with a power output of up to 30 watts per port

Model Number: 560771

8 x PoE ports,

8 x Standard RJ45 Ports

Model Number: 560849

16 x PoE ports



8

[8] PoE+ Web-Managed Gigabit Ethernet Switch with 2 SFP Ports

- Provides power and data connection for up to 16/24 PoE network devices
- 10/100/1000 auto-sensing ports automatically detect optimal network speeds
- Two small form-factor pluggable GBIC module slots (SFP)
- Total power budget of 180 Watts
- Supports IEEE 802.3at and IEEE 802.3af-compliant PoE devices (wireless access points, VoIP phones, IP cameras)

Model Number: 560535

16 PoE ports

Model Number: 560559

24 PoE ports



9

[9] 8-Port PoE+ Web-Managed Desktop Gigabit Switch

- Provides power and data connection for up to eight PoE network devices
- 10/100/1000 auto-sensing ports automatically detect optimal network speeds
- Total power budget of 130 Watts
- Supports IEEE 802.3at and IEEE 802.3af-compliant PoE devices (wireless access points, VoIP phones, IP cameras)

Model Number: 560542

[1] **Fast Ethernet PCI Network Card**

- Supports 10/100 speeds over network cable
- Full duplex speeds (20 Mbps, 200 Mbps)
- Supports the most popular operating systems: Windows XP, Vista and Windows 7/8

Model Number: 509510



[2] **Gigabit PCI Express Network Card**

- Supports Gigabit speeds over existing network cable
- Full duplex speeds (20 Mbps, 200 Mbps, 2000 Mbps)
- Wake-On-LAN (WOL) support

Model Number: 522533



[3] **Gigabit PCI Network Card**

- Supports Gigabit speeds over existing network cable
- Full duplex speeds (20 Mbps, 200 Mbps, 2000 Mbps)
- Wake-On-LAN (WOL) support

Model Number: 522328

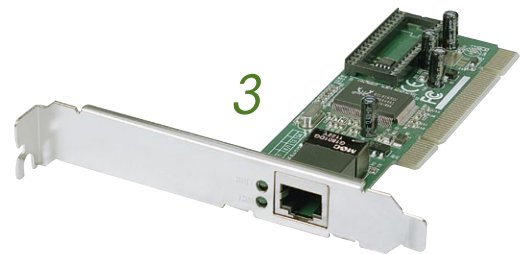

[4] **KVM Cable**

- HD15 male connector for connection to the KVM switch
- HD15 male connector for PC

Model Number: 505727

USB + PS/2, 1.8 m (6 ft.)

Model Number: 505734

USB + PS/2, 3.0 m (10 ft.)



[5] **KVM Extender PS/2**

- Supports video resolutions up to 1024 x 768
- Supports PS/2 mice and keyboards
- Computer connection to transmitter unit via 3-in-1 connection cable (included)

Model Number: 524353

Extend your KVM or Console up to 150 m (450 ft.)



[6] **Rackmount KVM Switch**

- Manage/control up to 8/16 PCs from a single keyboard, monitor and mouse
- 4-in-1 USB/PS/2 connection cables included
- Supports screen resolutions of up to 1600 x 900

Model Number: 506441

8-Port

Model Number: 506496

16-Port





[1] Gigabit Ethernet SFP Mini-GBIC Transceiver

- Data transfer rate: 1000 Mbps
 - Distance support: up to 550 m (50/125 μm cable) or 220 m (62.5/125 μm cable)
 - Compliant with SFP Transceiver MSA specifications
- 1000Base-SX (LC) Multi-Mode Port, 550 m
Model Number: 545006*
- 1000Base-LX (LC) Single-Mode Port, 20 km
Model Number: 506724*



[2] Fast Ethernet Media Converter

- Data transfer rate: 100 Mbps
 - One 10/100Base-TX RJ45 port, maximum distance 100 m / 300 ft.
 - Fiber distance support: up to 2 km / 1.24 mi (62.5/125 or 50/125 μm cable)
- Model Number: 506502 SC
Model Number: 506519 ST



[3] Gigabit Ethernet Media Converter

- Data transfer rate: 1000 Mbps
 - One 1000Base-T RJ45 port, maximum distance 100 m / 300 ft. (Cat5e and better)
 - Fiber distance support: up to 220 m / 720 ft (62.5/125 μm cable) or 550 m / 1800 ft (50/125 μm cable)
- Model Number: 506533

Expand the Size of Your Network

More business. More work. More staff. More workstations. Don't let it add up to more headaches. With the extensive line of office helpers available from Intellinet Network Solutions, you can project your future possibilities and plan accordingly.

Consider the rackmounting option on our PoE Desktop Gigabit Switch. You may not need it for a couple of quarters, but it's a feature that could save you more than a few company dollars when the time comes for network expansion. And don't forget about the network configuration benefits of our Power-over-Ethernet Splitters or Gigabit Ethernet Web-Smart Switches.

So whenever you feel the need to update or upgrade, we're here to fill the need with whatever makes the most sense while meeting all your requirements.



[1] NSC11 Network Camera

- Supports image resolutions up to 640 x 480 (VGA)
- Supports simultaneous MPEG4 and Motion-JPEG image compression
- Ultra-compact and easy to install

Model Number: 551106



[2] NSC11-WN Network Camera

- Supports image resolutions up to 640 x 480 (VGA)
- Supports simultaneous MPEG4 and Motion-JPEG image compression
- Ultra-compact and easy to install

Model Number: 551113 *150 Mbps Wireless*



[3] NFC30-WG Network Camera

- Supports image resolutions up to 640 x 480 (VGA)
- Supports 54 Mbps Wireless 802.11g with WEP, WPA & WPA2 encryption
- MPEG4 + Motion-JPEG + 3GPP mobile phone streaming, audio and 10x digital zoom

MPEG4 + Motion-JPEG Dual Mode, Audio, 300k CMOS, 54 Mbps Wireless 802.11g
Model Number: 550956



[4] NSC18-WN Pan/Tilt Network Camera

- Motorized wide-range pan and tilt control via Web browser and windows utility
- Supports image resolutions up to 1280 x 1024
- Integrated SD/SDHC card slot for on-board storage of up to 8 GB
- 4X digital zoom
- Supports WEP and WPA/WPA2 (TKIP and AES) data encryption

Model Number: 550857 *300 Mbps Wireless*



[5] IBC-637IR Outdoor Night Vision Megapixel HD Network Bullet Camera

- Wide Dynamic Range (WDR) automatically adjusts to deliver high-quality video even in the most difficult lighting conditions
- Infrared LEDs with 15 m effective range
- Supports IEEE 802.3af Power over Ethernet injectors, mid- and endspans
- IP67 rated, waterproof and dust tight

Model Number: 551366 *720p, 1 Megapixel*



[6] IBC-667IR Outdoor Night Vision 2 Megapixel HD Network Bullet Camera

- Built-in heater and fan allow operating the camera in severe environments as low as minus 40 degrees C/F
- Wide Dynamic Range (WDR) automatically adjusts to deliver high-quality video even in the most difficult lighting conditions
- Infrared LEDs with 35 m effective range
- Supports IEEE 802.3af Power over Ethernet injectors, mid- and endspans
- IP66 rated, waterproof and dust tight

Model Number: 551069 *1080p*



7



[7] IDC-862 HD 2 Megapixel Network Mini-Dome Camera

- Supports image resolutions up to 1920 x 1080 (1080p)
 - Ultra-compact, less than 10 cm (4 in.) in diameter
- Model Number: 551441 *1080p, 2 Megapixel*

8



[8] IDC-752IR Pro-Level Night Vision Megapixel Network IP Dome Camera

- Supports image resolutions up to 1280 x 720 (720p)
 - True day & night function: Removable IR-cut filter (ICR) ensures true color representation during the day and impressive night-vision performance at night
- Model Number: 551380

9



[9] IDC-757IR Outdoor Night Vision Megapixel Network Dome Camera

- Supports image resolutions up to 1280 x 720 (720p)
 - True day & night function: Removable IR-cut filter (ICR) ensures true color representation during the day and impressive night-vision performance at night
 - IP66-rated weather- and vandal-proof housing
- Model Number: 551397

10



[10] IDC-767IR Outdoor Night Vision 2 Megapixel Network Dome Camera

- Supports image resolutions up to 1920 x 1080 (1080p)
 - True day & night function: Removable IR-cut filter (ICR) ensures true color representation during the day and impressive night-vision performance at night
 - IP66 rated weather- and IK10-rated vandal-proof housing
- Model Number: 551410

11



[11] go1984 Software

- Video surveillance and recording solution for network cameras
- For use with all Intellinet Network Solutions Pro Series Network Cameras
- Can process digital network cameras and analog video sources that are connected via video servers or capture cards
- Live Monitoring

go1984 Enterprise Edition

Model Number: 505598

go1984 Professional Edition

Model Number: 505451

go1984 Ultimate Edition

Model Number: 551090

12



[12] Gigabit SATA NAS 3 TB

- Holds two 3.5" SATA hard drives (up to 1.5 TB each, not included)
- Supports RAID configurations (RAID 0, 1, JBOD)
- Integrated iTunes Digital Audio Access Protocol (DAAP) server delivers audio streams to any iTunes-compatible media player on the network
- Cross-platform file sharing for Windows, Linux and Mac OS

Model Number: 505895

- Certified Cat5e/Cat6 tested
- EIA/TIA approved
- Unique snagless boots
- 350 MHz



Length	Grey	White	Black	Red	Orange	Yellow	Green	Blue	Purple	Pink
Cat5e U/UTP										
0.5 m	318228	318082	318143	318198	341509	325165	318167	318129	453448	453059
1.0 m	318921	320672	320740	318952	338455	318969	318945	318938	453455	453066
1.5 m	336628	338370	338387	338394		338424	338417	338400	453462	453073
2.0 m	318976	320689	320757	319300	338288	319744	318990	318983	453479	453080
3.0 m	319768	320696	320764	319799	338295	319805	319782	319775	453486	453097
5.0 m	319812	320702	320771	319843	338301	319850	319836	319829	453493	453103
7.5 m	319867	320719	320788	319898	338318	319966	319881	319874	453509	453110
10.0 m	325950	345064	345378	325967	345385	325974	325943	325936		
15.0 m	319973	320726	320795	320603	338325	320610	319997	319980	453516	453127
20.0 m	345033	348188	345040	325998	345057	325981	326001	326018		
30.0 m	320627	320733	320801	320658	338332	320665	320641	320634	453530	453141
Cat5e F/UTP										
0.25 m	451307	451901	347440	451406	452007	451604	451703	451505		
0.5 m	329880	321998	331821	331845	313056	331814	331791	331838	453318	452922
1.0 m	329897	313883	330336	331869	313063	331890	331876	331852	453325	452939
2.0 m	329903	313377	331906	331944	313070	331937	331951	331913	453332	452946
3.0 m	329910	313384	330350	331982	313087	331975	332408	331968	453349	452953
5.0 m	329927	313001	330367	332019	313094	332033	332002	332026	453356	452960
7.5 m	329934	313018	335836	332064	313100	332385	332057	332040	453363	452977
10.0 m	329941	313025	330398	332088	313117	332101	332095	332071	453370	452984
15.0 m	329958		336666	332125		332392	332415	332118	453387	452991
20.0 m	329965	313032	331524	332545	313124	332569	332552	332132	453394	453004
30.0 m	329972									
Cat5e SF/UTP										
0.5 m	329989		320368	329996		330466	330442	330459	453579	453189
1.0 m	330473		320375	330480		330510	330497	330503	453585	453196
2.0 m	330527		335645	330534		330565	330541	330558	453592	453202
3.0 m	330572		320399	330589		330619	330596	330602	453608	453219
5.0 m	330626		320405	330633		330664	330640	330657	453615	453226
7.5 m	330671		336673	330688		330718	330695	330701	453622	453233
10.0 m	330831		320429	330848		330725	330855	330862	453639	453240
15.0 m	330732		337212	330749		330770	330756	330763	453646	453257
20.0 m	330787		320443	330794		330824	330800	330817	453653	453264
30.0 m	342636								453660	453271
Cat6 U/UTP										
0.5 m	340427	341936	342032	342131	342230	342339	342469	342568	393119	392754
1.0 m	340373	341943	342049	342148	342247	342346	342476	342575	393126	392761
1.5 m	340380	341950	342056	342155	342254	342353	342483	342582	393133	392778
2.0 m	334112	341967	342063	342162	342261	342360	342490	342599	393140	392785
3.0 m	334129	341974	342070	342179	342278	342377	342506	342605	393157	392792
5.0 m	336765	343732	343350	343367	343749	343725	343718	343305	393164	392808
7.5 m	336758	341998	342094	342193	342292	342391	342520	342629	393171	392815
10.0 m	336734	343800	343794	343756	343817	343787	343763	343770		
15.0 m	336772	342001	342100	342209	342308	342407	342537	342438	393188	392822
20.0 m	336741	730402	342117	342216		342445	342544	342421		
30.0 m	340557	342025	342124	342223	342322	342452	342551	342414		

- Certified Cat6 tested
- EIA/TIA approved
- Unique snagless boots



Length	Grey	White	Black	Red	Orange	Yellow	Green	Blue	Purple	Pink	Transparent	Brown*	Light Brown
Cat6 S/FTP													
0.5 m	341264	344029	344012	343978	344036	344005	343985	343992	392884	393225			
1.0 m	341271	344098	344081	344043	344104	344074	344050	344067	392891				
1.5 m	341288	344166	344159	344111	344173	344142	344128	344135	392907	392648			
2.0 m	341295	344234	344227	344180	344241	344210	344197	344203	392914	392655			
3.0 m	341301	344388	344371	344333	344395	344364	344340	344357	392921	392662			
5.0 m	344562	344586	344579	344524	344593	344555	344531	344548	392938	392679			
7.5 m	341325	344654	344647	344609	344661	344630	344616	344623	392945	392686			
10.0 m	342797	347693	347648	347686	347679	347709	347662	347655		393294			
15.0 m	341332	347761	347716	347754	347747	347778	347730	347723	392952	392693			
20.0 m	342803	313148	330312	330305	313155	330282	330299	330237					
30.0 m	341349	220088	220064	220095	220125	220149	220163	220071					
Cat6A S/FTP													
0.5 m	313162	313391	313841	314367	314886	315333	315715	316019					
1.0 m	313179	313407	313858	314374	314893	315340	315722	316026					
1.5 m	338929	313421	313865	314480	314909	315364	315739	316057					
2.0 m	338585	313414	313872	314497	314916	315371	315746	316064					
3.0 m	321785	313438	313889	314527	314923	315388	315753	316415					
5.0 m	321792	313445	313902	314619	314930	315395	315760	316422					
7.5 m	321822	313452	313919	314626	314947	315401	315777	316439					
Cat6, LSOH, S/STP													
0.25 m	733205	733342	733069	733625	733908	734042	733762	733489	734325	734189	734462		
0.5 m	733212	733359	733076	733632	733915	734059	733779	733496	734332	734196	734479		
1.0 m	733229	733366	733083	733649	733922	734066	733786	733502	734349	734202	734486		
1.5 m	733236	733373	733090	733656	733939	734073	733793	733519	734356	734219	734493		
2.0 m	733243	733380	733106	733663	733946	734080	733809	733526	734363	734226	734509		
3.0 m	733250	733397	733113	733670	733953	734097	733816	733533	734370	734233	734516		
5.0 m	733267	733403	733120	733687	733960	734103	733823	733540	734387	734240	734523		
7.5 m	733274	733410	733137	733694	733977	734110	733830	733557	734394	734257	734530		
10.0 m	733281	733427	733144	733700	733984	734127	733847	733564	734400	734264	734547		
15.0 m	733298	733434	733151	733717	733991	734134	733854	733571	734417	734271	734554		
20.0 m	733304	733441	733168	733724	734004	734141	733861	733588	734424	734288	734561		
25.0 m	733311	733458	733175	733731	734011	734158	733878	733595	734431	734295	734578		
30.0 m	733328	733465	733182	733748	734028	734165	733885	733601	734448	734301	734585		
50.0 m	733335	733472	733199	733755	734035	734172	733892	733618	734455	734318	734592		
Cat6, U/UTP, Flat Cable													
0.5 m		603102	603133									634915	603171
1.0 m		603201	604208									634922	604246
1.5 m		603195	603126									634793	634588
2.0 m		604260	603164									634823	634618
3.0 m		603188	622082									634809	634632
5.0 m		604253	603119									634816	634656
7.5 m		603225	603157									634700	634670
10.0 m		600226	600040									623773	634687
15.0 m		603218	601022									636599	634755
20.0 m		604277	604215									635202	634878

*Brown flat cables ideal for laminate and parquet flooring

Type	Wire	Color	Length	AWG	Model #
Cat5e					
UTP	Solid	Blue	305 m	24	327749
FTP	Solid	Grey	305 m	24	518130
UTP	Solid	Grey	305 m	24	325899
UTP	Solid	White	305 m	24	333078
FTP	Stranded	Grey	305 m	26	337892
UTP	Stranded	Grey	305 m	26	326032
Cat6					
SFTP	Solid	Grey	305 m	23	341165
UTP	Solid	Grey	305 m	23	334136
UTP	Stranded	Grey	305 m	26	334143
Cat5e SOHO					
UTP	Solid	Grey	305 m	24	362320
Cat6 SOHO					
UTP	Solid	Grey	305 m	23	704663
Cat.7 Install Cable, Solid					
S/FTP	Simplex	Orange	100 m	23	993883
S/FTP	Simplex	Orange	500 m	23	993890
S/FTP	Simplex	Orange	1000 m	23	993906
S/FTP	Duplex	Orange	100 m	23	993913
S/FTP	Duplex	Orange	500 m	23	993920

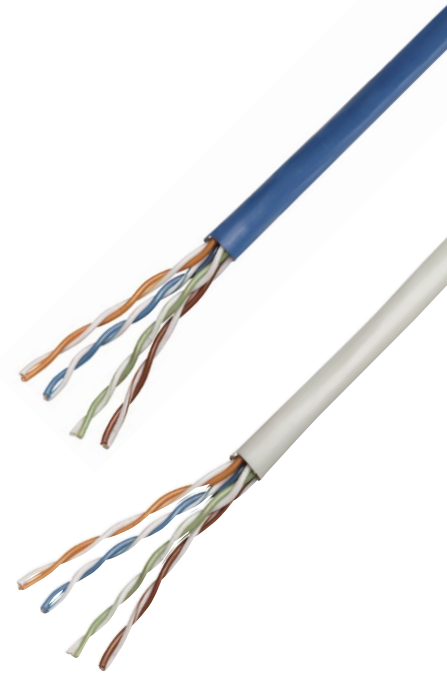

Due to volatility in the copper market, pricing is subject to change. Call your sales representative for current pricing.



For Data, Voice and Video

7



[1] Cat5e Patch Panel

- Solid and reliable terminations for copper cabling featuring a minimum of 3 mm 50 micro-inch gold-plated jack contacts
- Compatible with both 110 and Krone punch-down tools
- Supports 22 to 26 AWG stranded and solid wire

Model Number: 513555

24-Port, UTP, 1U

Model Number: 513579

48-Port, UTP, 2U

2



[2] Cat6 Patch Panel

- Solid and reliable terminations for copper cabling featuring a minimum of 3 mm 50 micro-inch gold-plated jack contacts
- Compatible with both 110 and Krone punch-down tools
- Supports 22 to 26 AWG stranded and solid wire

Model Number: 520959

24-Port, UTP, 1U

Model Number: 560283

48-Port, UTP, 2U

3



[3] Cat6 Shielded Patch Panel

- Solid and reliable terminations for copper cabling featuring a minimum of 3 mm 50 micro-inch gold-plated jack contacts
- Top-entry punch-down blocks simplify installation
- Compatible with Krone punch-down tools

Model Number: 720038

24-Port, FTP, 1U

[1] Inline Coupler

- 50 micron gold plated contacts
- Cat5e, 8P8C Female to 8P8C Female, UTP, Black*
- Model Number: 504775
- RJ-45, shielded*
- Model Number: 512008



[2] Cat5e Modular Inline Coupler

- Used to extend the length of shielded Cat5e cables
- 50 micron gold plated contacts
- Cat5e performance is in compliance with ANSI/TIA/EIA 568 B.2 standard
- Model Number: 504768



[3] Modular Inline Coupler

- 8P8C Female to 8P8C Female, UTP
- Model Number: 504225



[4] Modular Distributor

- Allows two RJ45 ports to share one Cat5 shielded network cable
- Used in pairs (one modular distributor on each end of the network cable)
- Requires a coupler (female to female) for connection on each end of the network cable
- Model Number: 504195



Category	Cable Type	Content	Packaging	Description	Model #
Modular Plugs					
Cat5e	for Installation Cable, Round Cable	100 Pieces	Jar	15µ Gold Plated	502399
Cat5e	for Patch Cable, Round Cable	100 Pieces	Jar	15µ Gold Plated	790055
Ca6	for Patch Cable, Round Cable	100 Pieces	Jar	15µ Gold Plated	502344



[1] ADSL Modem Splitter Adapter

- Separates the ADSL signal from the voice signals on a telephone line
 - Protects the voice signal and ADSL digital signal from the interference of a telephone and a fax machine
 - One RJ11 at one end for telephone line; two RJ11s at the other end for phone/fax and ADSL modem
- Model Number: 201124



[2] Multifunction Cable Tester

- Tests RJ-11 and RJ-45
 - Cable type: UTP/STP/FTP
- Model Number: 351898



[3] 4-in-1 Cable Tester

- Tests 4 types of cables: RJ-11/-45/USB/BNC
 - Simple one-button test
 - Tests patch cables and installed wiring
 - 600 ft. test distance
 - LEDs indicate connections and faults
 - Tests shielded and unshielded LAN cable
- Model Number: 351911



[4] Net Toner and Probe Kit

- Two position switch for single or multi-tone signal
 - LEDs for line polarity, continuity and voltage
 - Testing leads and modular cables for individual wire tests or modular jack tests
 - Alligator clips, RJ45 jack, RJ12 plug, optional F-connector
- Model Number: 515566



[5] Universal Modular Plug Crimping Tool

- Cuts and strips both round and flat cable
 - Ratchet type to control the tension of the tool; needs less strength; easy to operate
 - High-quality hardened steel with black oxide finish resists rusting
- Model Number: 211048



[6] Rotary Coaxial Cable Stripper

Model Number: 500494



Only 7 mm tall

[1] Micro 150N Wireless Adapter

- Fits discreetly into your netbook or laptop USB port
- Ideal for streaming HD-quality video, playing online games, downloading large files and making VoIP calls
- Supports WEP (64/128 bit), WPA and WPA2 data encryption

Model Number: 525503



[2] Range+ 150N Wireless Adapter

- Includes detachable 3 dBi high-gain antenna
- High transfer data rate - up to 150 Mbps
- Supports WEP (64/128 bit), WPA and WPA2 data encryption

Model Number: 525510



[3] Wireless 150N PCI Card

- Connects your desktop PC to a wireless network
- Detachable 3 dBi antenna with reverse SMA connector
- Supports WMM (Wi-Fi Multimedia) for increased multimedia data throughput

Model Number: 525473

[4] 300N Wireless Router

- Easy setup with the Manhattan ExpressWay™ utility
- Reliable wireless connection for surfing the Web, streaming media, online gaming and more
- Secure wireless connection with the push of a button thanks to Wi-Fi Protected Setup (WPS)
- Supports WEP and WPA/WPA2 (TKIP and AES) data encryption

Model Number: 525466



4



[5] Range+ 300N Adapter

- Up to 300 Mbps network link speed
- Supports Wi-Fi Protected Setup (WPS)
- Supports WEP (64/128 bit), WPA and WPA2 data encryption

Model Number: 525534



5



6



Only 9.5 mm tall

[6] Mini 300N Wireless Adapter

- Up to 300 Mbps network link speed
- Advanced technology with 2 internal antennas for enhanced throughput and coverage
- Supports WEP (64/128 bit), WPA and WPA2 data encryption

Model Number: 525527



7



Only 6 mm tall

[7] Mini 600AC Dual-Band Wireless Adapter

- Dual-band (2.4 GHz and 5 GHz) operation provides twice the bandwidth and less interference
- Supports WEP (64/128 bit), WPA and WPA2 data encryption

Model Number: 525602

[8] 1200AC Wireless Dual-Band Router

- Easy setup with the Manhattan ExpressWay™ utility
- Ideal for streaming HD-quality video, playing online games, downloading large files and making VoIP calls
- The latest in wireless technology transfer delivers up to 867 Mbps (5 GHz) and 300 Mbps (2.4 GHz) speeds
- Simultaneous dual-band operation (2.4 GHz and 5 GHz) provides twice the bandwidth

Model Number: 525480

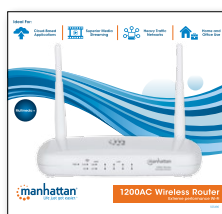

8



[9] Range+ 1200AC Dual-Band Wireless Adapter

- Dual-band operation provides twice the bandwidth and less interference
- Supports WEP (64/128 bit), WPA and WPA2 data encryption

Model Number: 525572



9



What is Wireless AC?

As part of our new Home Networking line, Manhattan is releasing a Dual-Band Wireless Router and two Wireless USB Adapters that use the new 802.11AC wireless standard (Wireless AC).

What is Wireless AC?

Wireless AC is the latest and greatest Wi-Fi standard, capable of delivering data transfer speeds and range that far surpasses the Wireless N and Wireless G standards used by most devices on the market today. It has dual-band capability, allowing it to handle a large number of connected devices with little interference. Plus, it uses "beamforming" technology to dramatically improve wireless signal range and fidelity.

Will it work with my existing wireless devices?

YES! Any Wi-Fi device in your home can and will work with a Wireless AC router. But, devices equipped with Wireless AC (or those using a Wireless AC USB Adapter) will enjoy higher performance.

What are the advantages to upgrading to Wireless AC?

In addition to super-fast data speeds, greatly-improved range and total compatibility, Wireless AC also offers:

- Virtually no in-game lagtime or timeouts.
- Decreased buffer lag and no annoying resolution changes in music and videos.
- A more efficient and effective Wi-Fi standard, meaning less power consumption while transmitting data.

The Bottom Line:

Wireless AC is the next generation of Wi-Fi. If you're shopping for a router, you probably want better performance for your network...and it doesn't get any better than this.

Our Wireless AC products include:

Model #	Product Name
525602	Mini 600AC Dual-Band Wireless Adapter
525572	Range+ 1200AC Dual-Band Wireless Adapter
525480	1200AC Wireless Dual-Band Router



manhattan-products.com

[10] 8-Port Fast Ethernet Switch

- Eight 10/100 auto-sensing ports automatically detect optimal network speeds
- Supports any combination of 10 Mbps or 100 Mbps network devices
- Ultra-compact design

Model Number: 560689



[11] Gigabit Ethernet Switch

- 10/100/1000 auto-sensing ports automatically detect optimal network speeds
- Green Ethernet power-saving technology deactivates unused ports

Model Number: 560696 5-Port

Model Number: 560702 8-Port

11



560702

[12] SimpleNet

- Provides network access for gaming consoles, Web-ready TVs, computers and more
- Uses the latest in HomePlug AV technology for faster speeds and enhanced security
- Ideal for HD-quality video streaming and online gaming
- Up to 500 Mbps network data rates and data security through 128-bit encryption

SimpleNet HomePlug AV500 Adapter

Model Number: 506663

SimpleNet Starter Kit, Includes two SimpleNet HomePlug AV500 Ethernet Adapters

Model Number: 506670

12



[13] USB 2.0 Fast Ethernet Adapter

- 10 times faster than USB 1.1 to Fast Ethernet adapters
- Add a network connection without opening up your PC
- Hot-swappable (no need to power down)

Model Number: 506731



13



[14] USB 3.0 Gigabit Adapter

- Upgrade your notebook or desktop computer to full gigabit speeds
- Quick and reliable sharing of large files over your network
- Supports SuperSpeed USB 3.0 interfaces and is downward compatible to High-Speed USB 2.0 and USB 1.1

Model Number: 506847



14



[15] UltraLynk

- Upgrade the USB and Ethernet capabilities of your Ultrabook or PC
- Provides 3 SuperSpeed USB 3.0 ports for additional drives and peripherals
- One Gigabit Ethernet (10/100/1000) port for faster downloads, media streaming and gaming

Model Number: 506892



15



[1] RightTrack Mouse

- RightTrack™ technology provides precise, accurate control on polished stone, dark glass, ceramics and more
- Top-mount push-button control instantly shifts resolution from 800 to 1600 dpi
- Compact size, ambidextrous shape with no-slip, rubber grip

Model Number: 177689	Yellow
Model Number: 177702	Red
Model Number: 177719	Blue
Model Number: 177733	Pink
Model Number: 177696	Orange
Model Number: 177726	Green



[2] Eclipse Mouse

- UltraTrack™ technology provides precise, accurate performance on nearly any surface – including clear glass
- Innovative touch-sensitive, wheel-free scrolling and control
- 2.4 GHz technology offers wireless freedom with effective range up to 10 m (33 ft.)

Model Number: 177757



[3] Contour Wireless Mouse

- Precision optical performance in an agile, modern design with USB micro receiver
- 2.4 GHz RF technology offers wireless freedom with effective range up to 10 m (33 ft.)
- Ergonomic shape and no-slip texture provide secure grip

Model Number: 178198



[4] Viva Wireless Mouse

- Precision performance that easily connects and operates without receiver
- Bluetooth technology offers wireless freedom with effective range up to 10 m (33 ft.)
- Push-button control instantly shifts resolution through three levels from 1000 to 2000 dpi

Model Number: 178235

[5] Silhouette Optical Mouse

- Sculpted, ultra sleek shape with accurate optical sensor
- Lightweight and slim size provide easy navigation and control
- Plug and Play installation — Windows and Mac compatible

Model Number: 177627 *White*

Model Number: 177658 *Black*



[6] Performance Wireless Optical Mouse

- 2.4 GHz RF technology offers wireless freedom with effective range up to 10 m (33 ft.)
- Top-mount push-button control instantly shifts resolution from 1000 to 2000 dpi
- Auto power management helps lengthen battery life up to 1.5 years

Model Number: 177795



[7] MH3 Classic Optical Desktop Mouse

- Accurate optical sensor and sturdy construction deliver reliable performance
- Basic, three-button with scroll wheel configuration — ideal for new systems, replacements and upgrades
- Compact-sized, ergonomic and ambidextrous design offers comfortable grip with less fatigue

Model Number: 177016 *USB*

Model Number: 177009 *PS/2*



[8] MO1 Optical Mini Mouse

- Compact size, ergonomic and ambidextrous design offers comfortable grip with less fatigue
- Low-friction base smoothly glides over work surfaces
- Plug and Play installation — Windows and Mac compatible

Model Number: 177955 *Metallic Blue*

Model Number: 177962 *Metallic Gray*

Model Number: 177979 *Wine*

Model Number: 177993 *Metallic Purple*



[9] Stealth Touch Mouse

- No buttons. Innovative Curve-Touch technology allows for wheel-free scrolling and fingertip control on the touch-sensitive surface.
- 2.4 GHz technology offers wireless freedom with effective range up to 10 m (33 ft.)

Model Number: 178013





1

[1] Roll-Up Keyboard

- Virtually indestructible design with silicone, latex-free construction suitable for almost any environment and user
- Easy-to-clean, hygienic surface and soft-touch key switches resist dust, moisture, spills and contaminants
- Lightweight, full-sized flexible case and silent operation ideal for mobile computing and netbooks

Model Number: 177436



2

[2] Enhanced Keyboard

- Streamlined, durable design ideal for new systems and replacement applications
- Ergonomic key arrangement
- Spill-resistant, low-force key switches provide quiet and positive tactile response

Model Number: 175708



3

[3] Slimline Edge Keyboard

- Contemporary, slim profile complements new desktops and is an easy upgrade
- Low-force key switches provide quiet, fast and positive tactile response

Model Number: 177917



4

[4] Multimedia Keyboard

- Modern design with essential multimedia controls helps improve speed — ideal for upgrade applications
- Ergonomic key arrangement
- 15 hotkeys offer quick, one-touch access to frequent multimedia functions

Model Number: 177870



5

[5] Multimedia Keyboard

- Modern design with essential multimedia controls helps improve speed — ideal for upgrade applications
- Ergonomic key arrangement
- 9 hotkeys offer quick, one-touch access to frequent multimedia functions

Model Number: 177788

[6] Tablet Mini Keyboard

- Pairs easily with Bluetooth enabled devices — tablets, desktops and smart phones
- Sleek, compact design makes this keyboard ideal for small workspaces
- Function keys offer easy access to Mac features

Model Number: 177887



[7] Numeric Keypad

- 19 full-size keys including backspace key
- Asynchronous number lock function operates independently of computer keypad for faster numeric data entry
- Scissor (X-structure) key switches reduce typing noise, improve response and provide low-profile keystrokes

Model Number: 176354



Exceptional Comfort, Durable Design

When it comes to “hands-on” experience, Manhattan knows what it takes to make mice, keyboards and keypads that are comfortable, compact and quiet.

Should tight or special surroundings be a primary concern, you have the space-saving Tablet Mini Keyboard or the rough-and-tough Roll-Up Keyboard to consider. For those who appreciate an eye-popping splash of color or a generous ration of features mixed in with exceptional ergonomics, take your pick of RightTrack Mice or go all out and impress your pals with the Contour Wireless Mouse.

Whichever you choose, you really can't lose — all Manhattan products are designed to perform and made to last.





[1] Web Communicator Combo

- 2-in-1 set enhances online communications, instant messaging, VoIP and more
- Self-adjusting camera optimizes color, exposure and brightness levels for maximum clarity
- High-performance sensor with powerful 4x digital zoom

Model Number: 460507



[2] HD 760 Pro Webcam

- Easily capture, record and share widescreen HD photos and video up to 720p – upload to Facebook, YouTube and more
- 12 megapixel image resolution with powerful 4x digital zoom function and built-in microphone
- Face tracking, automatic color, exposure and brightness levels maximize clarity in varying light conditions

Model Number: 460514



[3] Webcam 500

- Capture and share photos and video
- Adjustable clip base for easy attachment to desktop or notebook computers
- Included software simplifies settings and operation

Model Number: 460729

5 Megapixel



[4] Widescreen HD Webcam 860 Pro

- Easily capture, record and share HD photos and video up to 720p – upload to Facebook, YouTube and more
- 21 megapixel image resolution with powerful 4x digital zoom function and built-in microphone
- Face tracking, automatic color, exposure and brightness levels maximize clarity in varying light conditions

Model Number: 460545

[1] **HDMI Splitter**

- Delivers a sharp, clear signal from DVD and Blu-ray players, set-top box, satellite receiver and other sources
- Cascade up to three levels to expand signal distribution to more displays

Model Number: 177337 *HDMI 1.3, 2-port*
 Model Number: 177146 *HDMI 1.3, 4-port*



[2] **VGA Cat5/5e/6 Extender**

- Easily extends VGA and audio signals using Cat5/5e/6 cables for longer distance transmissions
- Supports VGA resolutions up to 1920 x 1200
- Delivers a sharp, clear signal with Gain and Peak adjustments

Model Number: 177344



[3] **Professional Video Splitter**

- Supports VGA bandwidths up to 350 MHz and resolutions up to 1920 x 1680 with effective transmission distance up to 65 m (210 ft.)
- Delivers a clear, sharp signal from a PC to VGA, SVGA and MultiSync displays, projectors and more
- Cascade up to three levels to expand signal distribution to more displays

Model Number: 207331 *2-Port*
 Model Number: 207348 *4-Port*
 Model Number: 207355 *8-Port*



[4] **Professional Video Splitter**

- Duplicates a video signal for up to 2 VGA outputs
- 400 MHz signal bandwidth
- Separate adjustable output level and line equalization controls help sharpen images and eliminate distortion and "shadows"

Model Number: 175135 *2-port*



[5] **Video Splitter**

- Duplicates a video signal for 2 VGA outputs
- 150 MHz signal bandwidth

Model Number: 177207 *2-port*



[6] **HDMI Cat5e/Cat6 Extender**

- Fully HDCP compliant to protect high-definition content transmission and ensure quality reception
- Cat5e/6 cable substitutes HDMI cable to achieve long distance transmission
- Supports the video amplifier bandwidth up to 1.65 Gbps for 1080p display

Model Number: 177269





[7] Hi-Speed USB DVI Converter

- Easily adds a monitor to a computer to expand visual areas
- Software manages up to 6 converters – easily add up to 6 displays to a single PC
- Supports DVI resolutions up to 1600 x 1200

Model Number: 179133



[8] VGA to HDMI Converter

- Easily converts VGA and stereo audio into an HDMI signal
- Ideal for connecting PCs to high-definition TVs, projectors, flat panel displays and more
- Delivers a clear, sharp transmission – supports up to 1280 x 1024 and 1080p resolution and video amplifier bandwidth up to 1.65 Gbps / 165 MHz

Model Number: 177351



[9] PC TV Converter

- Use TV as PC monitor to view presentations, games, pictures and movies or browse the Web
- Connects a VGA port to TV – ideal for computers without a TV-out connector
- Adjust and set preferences with onscreen display and front-mount control panel

Model Number: 150095



[10] Hi-Speed USB Audio/Video Grabber

- Easily capture media from camcorder, VCR, TV or other A/V source and transfer to computer
- Simple, single-button video snapshot and copy-and-pause control — encodes directly in MPEG 1/2/4 format
- Compact, lightweight design and easy installation ideal for travel and notebook computers

Model Number: 161336



14 x 23 x 53 mm

[11] Hi-Speed USB 3-D Sound Adapter

- Instantly creates mic-in/audio-out connectivity through any USB port – ideal for desktop, notebook and netbook PCs
- Improves access, bypasses faulty sound card or audio ports and upgrades audio performance
- Easy USB installation requires no external power or software

Model Number: 150859

[1] **Fathom Wireless Headphones**

- Over-ear design with plush, spacious ear cushions for maximum comfort
- Delivers high-quality wireless streaming from Bluetooth-enabled devices from up to 30' away
- Quick and easy wireless pairing with NFC-enabled devices
- Lithium polymer battery provides up to 15 hours of playback time (400 hours standby)

Model Number: 178709 *Black*
 Model Number: 178716 *White*



[2] **Flyte™ Wireless Headset**

- On-ear, adjustable design
- Built in, recessed microphone
- Soft, comfortable earpads
- Collapses for easy storage and carrying
- Flat USB and 3.5mm audio cables

Model Number: 178136



[3] **Fusion Wireless Headphones**

- On-ear design with soft, padded ear cushions for maximum comfort
- Delivers high-quality wireless streaming from Bluetooth-enabled devices from up to 30' away
- Built-in, recessed microphone
- Micro-USB charging cable included

Model Number: 178150 *White*
 Model Number: 178167 *Black*



[4] **Flex Wireless Headphones**

- On-ear, behind-the-head design with soft, padded ear cushions for maximum comfort
- Delivers high-quality wireless streaming from Bluetooth-enabled devices up to 30' away
- Built-in, recessed microphone
- Micro-USB charging cable included

Model Number: 178693



[5] **Freestyle Wireless Headphones**

- On-ear design with soft, padded ear cushions for maximum comfort
- Delivers high-quality wireless streaming from Bluetooth-enabled devices up to 30 ft away
- Built-in, recessed microphone
- Micro-USB charging cable included

Model Number: 178747 *Orange*
 Model Number: 178754 *Red*
 Model Number: 178761 *Black*





Are you free?

Combining the latest in wireless audio technology with super-clean, modern aesthetics, the Manhattan® Free Sound Series was created with performance, comfort and looks in mind. This series of headphones brings life to your favorite music, Web videos, movies and games from virtually any smartphone, tablet or laptop computer from up to 30 ft (10 m) away.

[6] Stereo Headset

- Comfortable padded ear cushions
- Adjustable support adapts to individual head size
- Flexible stainless steel microphone boom for hands-free communication

Model Number: 175517



[7] Elite Stereo Headset

- On-the-ear design provides comfort and enhances bass response
- Adjustable headband and padded ear cushions provide secure, relaxed fit
- In-line microphone helps reduce distortion and improve voice transmission

Model Number: 178044



[8] Classic Stereo Headset

- Comfortable padded cloth ear cushions
- Adjustable support adapts to individual head size
- Super bass system

Model Number: 175555



[9] Behind-The-Neck Stereo Headset

- Comfortable padded earphones
- "Behind-The-Neck" headband prevents hair style damage
- Flexible microphone boom for hands-free communication

Model Number: 175524



[10] Stereo Headset

- Stereo headphone with foam earpads
- Adjustable microphone and inline volume control for hands-free communication
- Easy to install with 3.5 mm stereo plugs

Model Number: 164429



[11] Stereo Headphones

- Stereo headphone with foam earpads
- Lightweight, comfortable design with adjustable split headband
- Long cord easily reaches desktop and notebook computers and other devices

Model Number: 177481



12



[12] **Signature Collection - SOCOM In-Ear Headphones**

- Dynamic, high-performance 11mm drivers for outstanding full-stereo sound
 - Sound-isolating, in-ear cushions for a comfortable fit and optimum performance
 - Gold-plated 3.5mm audio input plug
- Model Number: 178303 *SOCOM Pink*
 Model Number: 178310 *SOCOM Gray*

13



[13] **Signature Collection - In-Ear Headphones**

- High-performance 13mm drivers for outstanding full-stereo sound
 - Silicone-tip cushions for a comfortable and secure in-ear fit
 - In-line one-button control and windproof microphone
- Model Number: 178327 *Cellular*
 Model Number: 178358 *Spatterball*
 Model Number: 178334 *Mitosis*
 Model Number: 178341 *Ripple*



[14] **Color Accents - In-Ear Headphones**

- High-performance 10mm drivers for outstanding full-stereo sound
 - Silicone-tip cushions for a comfortable and secure in-ear fit
 - Standard 3.5mm audio input plug
- Model Number: 178259 *Azure Sky*
 Model Number: 178273 *Chill Tangerine*
 Model Number: 178266 *Spring Bloom*
 Model Number: 178297 *Sun Song*
 Model Number: 178280 *Violet Daydream*

14



[1] Lyric Mini™

- Pocket-sized, portable design is ideal for smartphones and tablets
- Compact 4Ω, 36mm driver delivers exceptional audio performance
- Pairs easily with most Bluetooth-enabled devices (Bluetooth 3.0 – reverse compatible)

Model Number: 161428



Only 54 mm tall

[2] Lyric Duo™

- Wireless pairing between speakers delivers unique, full-range stereo performance
- Enjoy premium audio performance from most Bluetooth-enabled devices
- High-performance 4Ω, 40mm drivers deliver vivid, realistic audio performance
- Bluetooth 2.1 (reverse compatible with V2.0) +EDR
- 10m (33-ft.) range between paired device and speakers; 4.6m (15-ft.) range between speakers

Model Number: 161367



Only 60 mm tall

[3] Lyric Solo™

- Delivers outstanding audio from most Bluetooth-enabled devices
- High-performance 4Ω, 40mm drivers deliver vivid, realistic audio performance
- Bluetooth 3.0 (reverse compatible with V2.0 and V2.1)
- Built-in, recessed microphone

Model Number: 161534



Only 54 mm tall

[4] Lyric Box™

- Enjoy exceptional audio performance from most Bluetooth-enabled devices
- High-performance 4Ω, 40mm drivers deliver rich, powerful sound
- Bluetooth 2.1 (reverse compatible with V2.0)

Model Number: 161923



Only 70 mm tall

5

Only 48 mm tall



[5] 2775 Soundbar Speaker System

- Full-range USB speaker system with rechargeable battery
- Volume control, on/off switch and LED power indicator
- Compact and portable with a self-contained wire management system
- Magnetic bases allow for conversion to Soundbar and easy storage

Model Number: 161664

6

Only 75 mm tall



[6] 2750 USB Speaker System

- Rich, full-range stereo sound from compact USB speakers
- Easily connects to laptop computers, PCs and other USB-equipped devices
- Ideal upgrade from headphones and built-in speakers
- Audio and power from a single USB connection

Model Number: 161671

7

192 mm tall



[7] 2900 Hi-Fi Speaker System

- Two-way speakers deliver rich, powerful sound — ideal for games, movies and music
- Solid cabinets help recreate a balanced, full-spectrum frequency response
- Shielded to prevent distortion and maintain clear, crisp sound

Model Number: 161695

8

Only 90 mm tall



[8] 2600 Series Speaker System

- Full-range stereo sound and compact size optimized for mobile listening
- Easily connects to notebook computers and other USB-equipped devices
- Self-powered and easy to install — require no batteries or power adapter

Model Number: 161435

9

170 mm tall



[9] 3050 2.1 Speaker System

- Experience stereo music with powerful, clear highs, a rich mid-range and deep lows
- Works with your PC or laptop
- All power is supplied via a USB connection — no separate power supply needed
- Volume and Bass controls

Model Number: 161701

[10] 2150 Speaker System

- Full-range, USB speaker system
- Volume control and LED power indicator with cloth grilles
- Shielded to prevent distortion and maintain clear, crisp sound

Model Number: 161725



10

133 mm tall

[11] 3775 Soundbar Speaker System

- Volume control with metal grilles that protect the drivers
- Unique magnetic design allow speakers to connect and form a soundbar
- Shielded to prevent distortion and maintain clear, crisp sound

Model Number: 161732



11

168 mm tall

[12] 2820 Laptop Speaker

- Full-range laptop USB speaker system
- Simple clip-on design
- Compact and portable with a wire management system
- Shielded to prevent distortion and maintain clear, crisp sound

Model Number: 161749

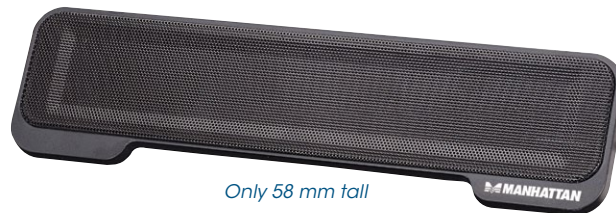

12

Only 58 mm tall

[13] Travel Speaker

- Compact speaker with built-in resonator expands to provide deep, full-range sound
- Connects to iPod, iPhone, notebook computers, MP3 and portable CD/DVD players, hand-held games and more
- Built-in rechargeable battery provides hours of use

Model Number: 161107



13

Only 65 mm tall when open

[14] Mobile Speaker System

- Dual function - rich, full-range sound from compact speaker with backup power supply
- Retractable resonator deepens and expands bass response
- Built-in rechargeable battery provides hours of use

Model Number: 150125



14

Only 60 mm tall

[1] Contact CCD Barcode Scanner

- Wide scan field provides quick, accurate reads with up to 300 scans per second
- Detects many popular symbologies including UPC, EAN and GS1 DataBar

Model Number: 460866 55 mm Scan Width, USB
 Model Number: 401517 80 mm Scan Width, USB

[2] Contact CCD Barcode Scanner

- Keyboard Wedge Decoder displays data as if directly entered from keyboard
- Wide scan field provides quick, accurate reads with up to 100 scans per second
- Detects many popular symbologies including UPC, EAN, 1D barcodes, ASCII, GS1 DataBar Family and more

Model Number: 178488 60 mm Scan Width, USB

[3] Long Range CCD Barcode Scanner

- Keyboard Wedge Decoder displays data as if directly entered from keyboard
- Wide scan field provides quick, accurate reads with up to 270 scans per second up to 300 mm (10 in.) away
- Detects many popular symbologies including UPC, EAN and GS1 DataBar

Model Number: 460835

[4] Long Range CCD Barcode Scanner

- Keyboard Wedge Decoder displays data as if directly entered from keyboard
- Wide scan field provides quick, accurate reads with up to 150 scans per second up to 260 mm (10 in.) away
- Detects many popular symbologies including UPC, EAN and GS1 DataBar

Model Number: 177672

[5] Wireless Linear CCD Barcode Scanner

- Wireless Bluetooth technology offers effective range up to 80 m (264 ft.) in line of sight
- Keyboard Wedge Decoder displays data as if directly entered from keyboard
- Detects many popular symbologies including UPC, EAN, 1D barcodes, ASCII, GS1 DataBar Family and more

Model Number: 178495

[6] Wireless Linear CCD Barcode Scanner

- Wireless Bluetooth technology offers effective range up to 80 m (264 ft.) in line of sight
- Keyboard Wedge Decoder displays data as if directly entered from keyboard
- Detects many popular symbologies including UPC, EAN, 1D barcodes, ASCII, GS1 DataBar Family and more
- Rugged housing with IP42 sealing

Model Number: 178617



[7] Linear CCD Barcode Scanner

- Keyboard Wedge Decoder displays data as if directly entered from keyboard
- Wide scan field provides quick, accurate reads with up to 500 scans per second up to 500 mm (20 in.) away
- Detects many popular symbologies including UPC, EAN, 1D barcodes, ASCII, GS1 DataBar Family and more
- Rugged housing with IP54 sealing

Model Number: 178433



[8] Laser Barcode Scanner

- Keyboard Wedge Decoder displays data as if directly entered from keyboard
- Wide scan field provides quick, accurate reads with up to 500 scans per second up to 300 mm (12 in.) away
- Detects many popular symbologies including UPC, EAN, 1D barcodes, GS1 DataBar Family and more

Model Number: 178211



[9] 2D Barcode Scanner

- Helps speed data entry, reduce errors and improve efficiency – ideal for retail transactions and automated processes
- Wide scan field provides quick, accurate reads with up to 200 scans per second up to 430 mm (17 in.) away
- Detects many popular 1D and 2D symbologies including UPC, EAN and more

Model Number: 177603



[10] Barcode Scanner Stand

- Suitable for table, counter or wall mount – ideal for retail and other applications
- Maximum height up to 26 cm (10 in.)
- Compatible with MANHATTAN 460873, 400954, 460828, 400961, 460835, 460903, 460910 and 177603 handheld barcode scanners

Model Number: 460842

[11] Magnetic Strip Card Reader

- Helps speed data entry, reduce errors and improve efficiency – ideal for retail transactions, access control and ID verification
- Keyboard Wedge Decoder displays data as if directly entered from keyboard
- Bi-directional swipe reads most bank cards, membership and ID badges, gift cards, driver's licenses and more

Model Number: 460255



[12] Smart Card Reader

- Compatible with friction-type, contact smart cards
- Ideal for transactions and applications requiring secure information exchanges
- Supports host communication speeds up to 12 Mbps

Model Number: 172844





1

[1] Hi-Speed USB Flex Hub

- Provides four Hi-Speed USB ports for additional peripherals
- Each port rotates 180° to easily connect most USB devices
- Vibrant purple, red, orange, yellow and green colors help identify cables and connections – add interest and fun

Model Number: 161053



2

[2] Hi-Speed USB Hub

- Provides four Hi-Speed USB ports for additional peripherals
- Add fun and excitement to your desktop

- Model Number: 161503 *Dog Bone*
- Model Number: 161510 *Flower Pot*
- Model Number: 161527 *Stacked Cookies*
- Model Number: 161541 *Gold Bar*
- Model Number: 161558 *Caterpillar*
- Model Number: 161626 *Running Man*
- Model Number: 161633 *Adjustable Man*



[3] Phone Stand USB Hub

- Provides four Hi-Speed USB ports for additional peripherals
- Non-slip surface holds your smartphone at the perfect angle

Model Number: 161565



3

[4] iLynk Hub+

- Add an additional USB 2.0 port
- Compact and convenient to carry

Model Number: 161657

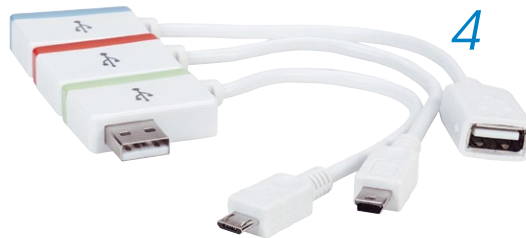

4



5



[5] Hi-Speed USB Hub

- Provides seven Hi-Speed USB ports to connect additional peripherals
- Versatile bus or AC powered with over-current protection; hot-swappable
- Easy-to-read power and port LED indicators

Model Number: 160766

[6] Hi-Speed USB Micro Hub

- Provides four Hi-Speed USB 2.0 ports for additional peripherals
- Built-in, self-storing USB cable ideal for notebook computers with rear-mount ports
- Overcurrent protection and hot-swappable

Model Number: 160605



[7] Hi-Speed USB Micro Hub

- Provides four Hi-Speed USB 2.0 ports for additional peripherals
- Compact size ideal for both desktop and notebook computers
- Over-current protection; hot-swappable

Model Number: 160612



[8] Hi-Speed USB Pocket Hub

- Built-in, self-storing USB cable ideal for notebook computers with rear-mount ports
- Over-current protection; hot-swappable
- LED power indicator

Model Number: 160599



[9] Hi-Speed USB Pocket Hub

- Built-in, self-storing USB cable ideal for notebook computers with rear-mount ports
- Power-only USB connection eliminates the need for power adapters
- LED power indicator

Model Number: 161169



[10] Hi-Speed USB Ultra Hub

- Provides seven Hi-Speed USB 2.0 ports for additional peripherals
- Multiple Transaction Translator supports low-speed and high-bandwidth USB devices for optimum performance
- Built-in, wrap-around cable easily connects and protects ports when not in use

Model Number: 161039





[11] **MondoHub**

- Provides 28 Hi-Speed USB ports for additional peripherals
- Replaces less-capable hubs with compact multiport design and high-capacity 4-amp power adapter
- Conveniently recharges mobile devices and connects flash drives, receivers, card readers and more

Model Number: 161718



[12] **Hi-Speed USB Desktop Hub**

- Provides 13 Hi-Speed USB ports for additional peripherals
- Replaces less-capable hubs with compact multi-port design and high-capacity 4-amp power adapter
- Conveniently recharges mobile devices and connects flash drives, receivers, card readers and more

Model Number: 161022



[13] **Hi-Speed USB Desktop Hub**

- Provides 10 Hi-Speed USB ports for additional peripherals
- Replaces less-capable hubs with compact multi-port design
- Conveniently recharges mobile devices and connects flash drives, receivers, card readers and more

Model Number: 161572



[14] **Hi-Speed USB Combo Hub**

- Provides three Hi-Speed USB 2.0 ports for additional peripherals
- Compatible with Memory Stick, SecureDigital and MultiMedia - no power supplies or adapters required
- Built-in, self-storing USB cable ideal for notebook computers with rear-mount ports

Model Number: 100984



[15] **Hi-Speed USB Internal Hub**

- Provides four Hi-Speed USB front-mount ports for additional peripherals
- Easy installation in any 3.5" drive bay for convenience and accessibility

Model Number: 350310



[1] USB to Serial Converter

- Quickly adds RS232 ports to a single USB port
- Easily connect most serial modems, digital cameras, label writers, card readers, barcode scanners, palm PCs and digital organizers
- Windows compatible — Plug and Play; hot-swappable

Connects One Serial Device To A USB Port

Model Number: 205153

Connects One Serial Device To A USB Port

Model Number: 205146

Connects Two Serial Devices To A USB Port

Model Number: 174947

Connects Up to Four Serial Devices To A USB Port

Model Number: 151047

Connects Up to Eight Serial Devices To A USB Port

Model Number: 151054



[2] USB to Parallel Printer Converter

- Converts USB signals for use with IEEE 1284 devices – supports data transfer speeds up to 12 Mbps
- Ideal for connecting a computer USB port to parallel printer
- Bus power support requires no external power supply

Model Number: 317474

USB A to Cen36 Male



[3] USB to Parallel Printer Converter

- Converts USB signals for use with IEEE 1284 devices – supports data transfer speeds up to 12 Mbps
- Ideal for connecting a computer USB port to parallel printer
- Windows 7/8 compatible — Plug and Play; hot-swappable

Model Number: 317016

USB A to Cen36 Male



[4] Full Speed USB to Parallel Printer Converter

- Converts USB signals for use with IEEE 1284 devices – supports data transfer speeds up to 1.2 Mbps
- Ideal for connecting a computer USB port to parallel printer
- Plug and Play installation; Windows compatible

Model Number: 336581

A Male to DB25 female



[5] USB to RS485 Converter

- Quickly adds an RS485 connection to a single USB port
- Easily converts RS485 industrial buses to a USB interface
- Hassle-free configuration of two-wire half duplex networks up to 1200 meters

Model Number: 150439

80 cm (31.5 in.)



[6] Hi-Speed USB 2.0 SVGA Converter

- Easily adds a monitor to a computer to expand visual areas
- Software manages up to 6 converters – easily add up to 6 displays to a single PC
- Primary, extended and mirror functions provide display continuity and multiple views
- Supports resolutions up to 1600 x 1200 in 16-bit or 32-bit color

Model Number: 179225





7

[7] Hi-Speed USB to SATA/IDE Adapter

- Provides fast data access to IDE and SATA drives with one-touch backup
- Supports data transfer SATA speeds up to 1.5 Gbps and Hi-Speed USB speeds up to 480 Mbps
- Supports 48-bit LBA (Logical Block Addressing)

Model Number: 179195

[8] USB to PS/2 Converter

- Easily connect two PS/2 peripherals through a single USB connection
- Ideal for connecting full-sized keyboard and mouse to notebook and desktop computers
- Molded PVC boot with strain relief helps maintain reliable connections

Model Number: 179027

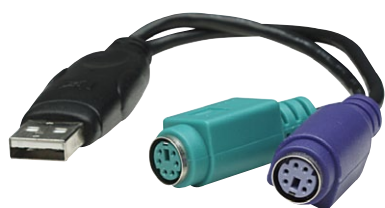

8



9

[9] USB 2.0 to HDMI Adapter

- Easily converts USB video and stereo audio into an HDMI signal
- Ideal for connecting PCs to high-definition TVs, projectors, flat panel displays and more
- Delivers a clear, sharp transmission – supports 1080p high-definition video with a widescreen aspect ratio of 16:9

Model Number: 151061



10

[10] SuperSpeed USB to SATA Adapter

- Easily connects a SATA hard drive to a SuperSpeed USB port to quickly transfer, back up and store files
- Supports data transfer SATA speeds up to 3 Gbps and USB 3.0 speeds up to 5 Gbps
- Supports 48-bit LBA for drives up to 2 TB

Model Number: 150705



11

[11] Hi-Speed USB Active Cable

- Extends and boosts the signal to any USB device – supports data transfer speeds up to 480 Mbps
- Overcomes the 5 m (16 ft.) USB distance limitation – ideal for connecting most USB printers
- Provides a single, nondaisy-chainable extension for maximum distance of 11 m (36 ft.)

Model Number: 510424

[12] Hi-Speed USB Active Extension Cable

- Extends and boosts the signal to any USB device – supports data transfer speeds up to 480 Mbps
- Overcomes USB distance limitation – ideal for connecting enclosures and other peripherals

A Male / A Female, 5 m (16 ft.), Daisy-chain up to three extensions for total distance of 15 m (50 ft.)

Model Number: 519779

A Male / A Female, 10 m (33 ft.), Daisy-chain up to three extensions for a total distance of 30 m (99 ft.)

Model Number: 150248

A Male / A Female, 20 m (65 ft.), Daisy-chain two extensions for total distance of 40 m (131 ft.)

Model Number: 150958



[13] SuperSpeed USB Active Extension Cable

- Extends and boosts the signal to any USB device – supports data transfer speeds up to 5 Gbps
- Built-in repeater helps maintain USB 3.0 signal quality, electrical and timing specifications

Model Number: 150712 *A Male / A Female*



[14] USB Line Extender

- Extends the distance of barcode scanners, printers, digital cameras, keyboard/mouse extensions and other USB devices from a USB-enabled computer
- Embedded transceivers enhance signal and prevent signal loss
- Bus powered – requires no external power supply

Extends The Distance Up To 60 m (196 ft.)

Model Number: 179300



[15] Multi-Card Reader/Writer

- Easily access media and manage content almost anywhere
- Includes slot-to-slot read/write/copy and USB mass storage capabilities

Model Number: 100762



[16] Multi-Card Reader & Writer

- Easily access media and manage content almost anywhere
- Supports automatic card detection and USB 3.0 data transfer speeds up to 5 Gbps
- 5 LED lights for memory card status
- Eliminates need for direct connection of media device to save battery power

Model Number: 101653



17



[17] Multi-Card Reader/Writer

- Easily access media and manage content almost anywhere
- Includes USB mass-storage capabilities
- Compatible with CompactFlash, Microdrive, Memory Stick, MagicGate, SecureDigital and Multimedia

Model Number: 100939

18



[18] USB 3.0 Multi-Card Reader & Writer

- Easily access media and manage content almost anywhere
- Supports automatic card detection and USB 3.0 data transfer speeds up to 5 Gbs
- Eliminates need for direct connection of media device to save battery power

Model Number: 101660

72 x 28 x 15 mm

19



[19] USB 2.0 Multi-Card Reader & Writer

- Compatible with Memory Stick, SecureDigital and MultiMedia – no power supplies or adapters required
- Easily access media and manage content almost anywhere includes read/write/copy
- Supports automatic card detection and data transfer speeds up to 480 Mbps

Model Number: 101707

49 x 25 x 9 mm

20



[20] Mini USB 2.0 Multi-Card Reader & Writer

- Easily access media and manage content almost anywhere with slot-to-slot read/write/copy and USB mass storage capabilities
- Compatible with SecureDigital (SD), MultiMedia memory cards (MMC) and microSD
- Supports automatic card detection and data transfer speeds up to 480 Mbps

Model Number: 101677

21



[21] Smart Card Reader

- Compatible with friction-type, contact smart cards
- Ideal for transactions and applications requiring secure information exchanges
- Supports host communication speeds up to 12 Mbps

Model Number: 172844

22



[22] Multi-Card Reader/Writer

- Convenient front-mount USB port
- Compatible with CompactFlash, Microdrive, Memory Stick, MagicGate, SecureDigital, Multimedia and XD
- Supports Automatic Card Detection and data transfer speeds up to 480 Mbps

Model Number: 100915

[1] Multi-Function SATA Quick Dock

- Provides fast data access to portable storage and SATA drives with One-Touch Backup
- Dual insertion slot accepts 3.5" and 2.5" SATA high-capacity hard-disk drives with 2-port Hi-Speed USB hub for additional peripherals
- Compatible with CompactFlash, Microdrive, Memory Stick, MagicGate, SecureDigital and Multimedia

Model Number: 130004



[2] SATA Quick Clone Dock

- Provides fast data access, creates portable storage and simplifies hard-disk drive backup and exchanges
- One-touch cloning replicates HDD while attached or unattached to PC
- Dual insertion slots accept 3.5" and 2.5" SATA hard-disk drives up to 2 TB

Hi-Speed USB/eSATA to Dual SATA, 3.5"/2.5"

Model Number: 130219

SuperSpeed USB to Dual SATA, 3.5"/2.5"

Model Number: 130226



[3] eSATA Quick Dock

- Provides fast data access to SATA drives
- Dual insertion slot accepts 3.5" and 2.5" SATA high-capacity hard-disk drives
- Supports Hi-Speed USB and eSATA data transfer rates up to 3 Gbps

eSATA & USB 2.0 3.5"/2.5" SATA Hard Drive Docking Station

Model Number: 130271



[4] QuickDock™

- Provides fast data access to SATA drives
- Insertion slots accept 3.5" and 2.5" SATA high-capacity hard-disk
- Supports SuperSpeed USB data transfer rates up to 5 Gbps

Model Number: 130356

QuickDock™ - 1 Bay

Model Number: 130363

QuickDock™ Duo - 2 Bay

Model Number: 130370

QuickDock™ Quattro - 4 Bay



130363



[5] CPU Thermal Grease

- Increases thermal conductivity between CPU and heat sink
- Helps dissipate damaging heat to prolong CPU life
- Syringe dispenser with resealable cap for precise and easy application

Model Number: 701662



5



1

[1] Drive Enclosure

- Supports data transfer rates for up to 480 Mbps
- Lightweight, compact design ideal for portable storage
- Fits standard 2.5 in. SATA drives with easy, quick installation – includes built-in USB cable

Model Number: 130042



2

[2] Drive Enclosure

- Supports data transfer rates for up to 480 Mbps and large-capacity drives up to 2 TB
- Lightweight, compact design ideal for portable storage
- Fits standard 3.5" SATA drives with easy, quick installation — includes rear-mount power switch and LED indicator

Model Number: 130288



3

[3] Drive Enclosure

- Supports USB 3.0 data transfer rates for up to 5 Gbps and large-capacity drives up to 3 TB
- Sturdy case protects drive and facilitates cooling
- Fits standard 3.5" SATA drives with easy, quick installation — includes rear-mount power switch and LED indicator

Model Number: 130295



4

[4] Drive Enclosure

- Supports USB 3.0 data transfer rates for up to 5 Gbps and large-capacity drives up to 1 TB
- Integrated one-touch copy button and power/activity LED indicator
- Fits standard 2.5" SATA drives with easy, quick installation and LED indicator

Model Number: 130349



5

[5] Drive Enclosure

- Supports data transfer rates for up to 480 Mbps
- Silicone construction provides snug, cushioned fit that protects drive and permits ventilation
- Fits standard 2.5 in. SATA drives with easy, quick installation – includes built-in USB cable

Model Number: 130103

Black

Model Number: 130110

Blue

[1] **Hi-Speed USB PCI Card**

- Adds 4 external and 1 (shared) Internal Hi-Speed USB ports
- Supports data transfer rates of up to 480 Mbps
- Plug and Play installation; hot-swappable — Windows compatible

4 External or 3 External with 1 Internal Connections
Model Number: 171557



[2] **SuperSpeed USB PCI Express Card**

- Easily adds two SuperSpeed USB ports to desktop computers
- Each port supports USB 3.0 data transfer rates of up to 5 Gbps
- Fits PCI Express x1, x2, x4, x8 and x16 lane buses

Two external SuperSpeed USB ports, x1 lane
Model Number: 150491

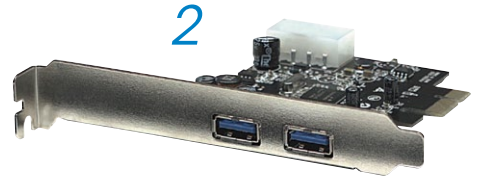

[3] **Serial PCI Card**

- Adds 4 high-speed 16C950 UART serial DB9 Com ports to desktop computers
- Each port features individually controlled 5 V DC operation
- Up to 460 kbps throughput

Model Number: 175586 4 Port Adapter

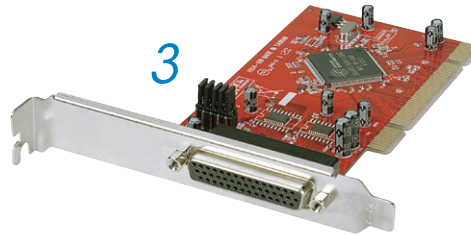

[4] **Serial PCI Card**

- Maximum 115.2 kbps throughput
- Universal bus power design for 5 V and 3.3 V

Model Number: 158213 Two External DB9 Ports
Model Number: 158206 One External DB9 Port

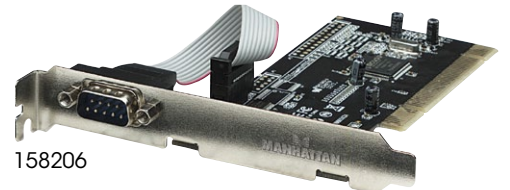

[5] **Serial PCI Express Card**

- Fits PCI Express x1, x2, x4, x8 and x16 lane buses
- Fits standard and low-profile PCI slots

Model Number: 158152 One port, x1 lane
Model Number: 158169 2 Ports, x1 Lane



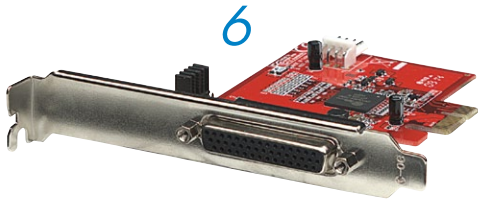

[6] Serial PCI Express Card

- Adds 4 high-speed 16C950 UART serial DB9 Com ports to desktop computers
- Each port features individually controlled 5 V DC operation
- Up to 460 kbps throughput

Model Number: 150682

4 Port Adapter

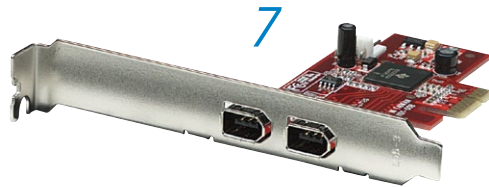

[7] FireWire 400 PCI Express Card

- Easily adds two FireWire 400 ports to desktop computers
- Each port supports data transfer rates of up to 400 Mbps
- 12 V DC connector uses bus power to recharge and supply connected FireWire devices

Model Number: 160353

Two ports, x1 lane

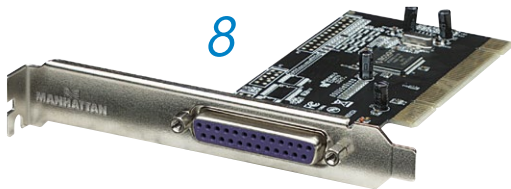

[8] Parallel PCI Card

- Easily adds one parallel port to a desktop computer
- Supports EPP, ECP and SPP modes
- Universal bus power design for 5 V and 3.3 V

Model Number: 158220

One External DB25 Port



[9] Parallel PCI Express Card

- Easily adds one parallel port to a desktop computer
- Supports SPP, EPP and ECP ports
- Fits standard and low-profile slots

Model Number: 158176

One port, x1 lane



[10] PCI Express to ExpressCard Adapter

- Provides a quick solution for adding an Express Card socket to desktop computers
- Ideal for sharing Express Cards between desktop and notebook computers

Supports Express Card/34 and Express Card/54

Model Number: 160513

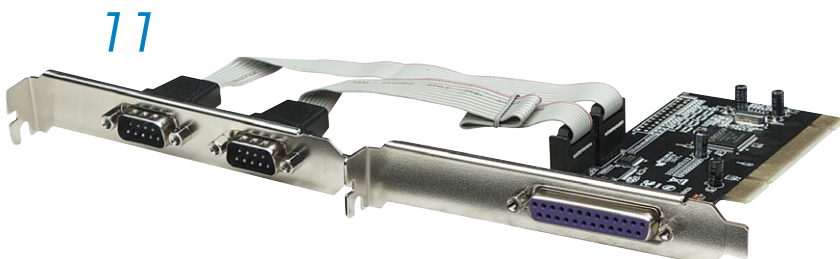

[11] Serial/Parallel Combo PCI Card

- Adds two external high-speed 16C550 UART serial DB9 Com and one parallel DB25 external ports to desktop computers
- Maximum 115.2 kbps throughput on each serial port
- Up to 1.5 Mbps parallel throughput
- Parallel DB25 port supports Enhanced Parallel Port (EPP), Standard Parallel Port (SPP) and Enhanced Capability Port (ECP)

Two Serial DB9 + One Parallel DB25 External Ports

Model Number: 158251

[12] USB Modem

- Easy USB installation - no external power supply needed
- Quick Connect, auto dial/answer, tone/pulse dialing and improved download speeds
- Supports Digital Telephone Answering Machine (TAM)
- Downstream speeds up to 56 kbps

Model Number: 154109 56k



[13] SATA 1.5 Gb/s RAID Controller PCI Card

- Easily adds two internal SATA 150 ports, each supporting SATA 150 data transfer rates of up to 1.5 Gbps
- Provides RAID 0 (striping) and RAID 1 (mirroring)
- Fits standard and low profile PCI slots

Model Number: 176767 Two Internal Ports

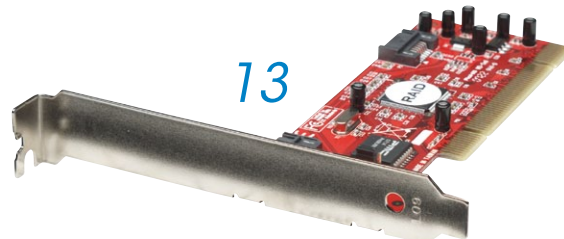

[14] SATA 3 Gb/s RAID PCI Express Card

- Supports 1-lane 2.5 Gbps PCI Express, SATA transfer rate of 3.0 Gbps and RAID 5 data transfer rates
- Includes low-profile PCI bracket

Model Number: 150965 Two external ports

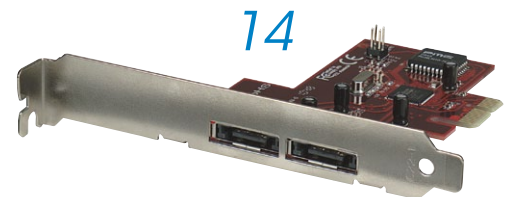

[15] IDE to SATA 150 Converter

- Supports SATA 150 data transfer rates of up to 1.5 Gbps
- Compatible with most IDE devices
- Attach IDE drives to standard SATA connections

Converts any IDE Drive to a SATA 150 Controller
Model Number: 170598

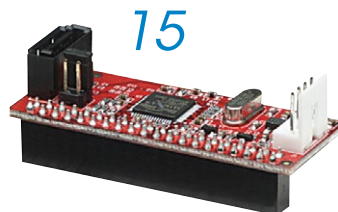

[16] SATA 300 to IDE Converter

- Supports SATA devices with transfer rates of up to 3 Gbps
- Easily attaches SATA drives to IDE connections
- Ideal for Blu-ray, SSD, DVD, DVD-RAM, CD-ROM, CD-RW and hard drives

Connects a SATA Drive to an IDE Controller
Model Number: 158282



[17] SuperSpeed USB ExpressCard/34

- Easily adds two SuperSpeed USB ports to notebook computers
- Supports USB 3.0 data transfer rates of up to 5 Gbps
- Fits ExpressCard/34 and ExpressCard/54 slots

Two SuperSpeed USB ports
Model Number: 151405





[1] 2-Port Mini KVM Switch

- Operate two computers with one keyboard, mouse and monitor
- Hotkey commands and LED indicators for computer selection
- Supports resolutions up to 1920 x 1440 pixels

Model Number: 151245 USB
 Model Number: 151238 PS/2



[2] 2-Port USB Compact KVM Switch

- Manage/control 2 USB computers from one keyboard, monitor and mouse
- Channel selection via push buttons and keyboard hotkeys
- Includes two connection cables for computer, speaker and microphone connection

Model Number: 151252



[3] 4-Port USB Compact KVM Switch

- Manage/control four USB computers from one keyboard, monitor and mouse
- Channel selection via push buttons and keyboard hotkeys
- Includes four connection cables for computer, speaker and microphone connection

Model Number: 151269

More Connections, Better Performance

Our KVM switches have USB support on the console side which allows you to use a USB keyboard and mouse. It also allows you to access, control, boot and reboot multiple USB-enabled computers with only one USB keyboard, mouse and monitor.



	Name	Description	Main Feature	Length	Model #
USB Cables					
	USB 3.0 Device Cable	A Male / B Male, Blue, Retail Packaging	Supports speeds of up to 5 Gbps	2 m	391863
	USB 3.0 Device Cable	A Male / B Male, Blue, Bag	Supports speeds of up to 5 Gbps	2 m	322430
				3 m	322454
	USB 3.0 Device Cable	A Male / B Male, Blue, Retail Blister	Connects a SuperSpeed USB device to a SuperSpeed USB hub or computer	2 m	393881
		A Male / Micro B Male, Blue, Retail Blister		1 m	393898
	USB 3.0 Extension Cable	A Male / A Female, Blue, Bag	Extends a USB cable length	2 m	322379
				3 m	322447
	USB 3.0 Device Cable	A Male / Micro B Male, Blue, Bag	Supports speeds of up to 5 Gbps	1 m	325417
				2 m	325424
	USB 2.0 Device Cable	A Male / Micro-B Male, Black, Bag	Supports speeds of up to 480 Mbps	0,5 m	325677
				1,8 m	307178
	USB 2.0 Device Cable	A Male / Micro-B Male, Black, Retail Blister	Connects a Hi-Speed USB device to a Hi-Speed USB hub or computer	0,5 m	393867
				1 m	393874
	USB 2.0 Device Cable	A Male / Micro-B Male, Black, Retail Packaging	Supports speeds of up to 480 Mbps	1,8 m	393256
	USB 2.0 Device Cable	A Male / B Male, Black, Bag	Supports speeds of up to 480 Mbps	1,8 m	333368
				3 m	333382

	Name	Description	Main Feature	Length	Model #
USB Cables cont.					
	USB 2.0 Device Cable	A Male / B Male, Black, Retail Blister	Connects a Hi-Speed USB device to a Hi-Speed USB hub or computer	1,8 m	393737
				3 m	393829
	USB 2.0 Device Cable	A Male / B Male, Black, Retail Blister	Connects a Hi-Speed USB device to a Hi-Speed USB hub or computer	3 m	390231
	USB 2.0 Device Cable	A Male / B Male, Translucent Silver, Bag	Supports speeds of up to 480 Mbps	1,8 m	333405
				3 m	340458
				5 m	345408
	USB 2.0 Device Cable	A Male / B Male, Translucent Silver, Retail Blister	Connects a Hi-Speed USB device to a Hi-Speed USB hub or computer	4,5 m	393836
	USB 2.0 Device Cable	A Male / Mini-B Male, Black, Bag	Supports speeds of up to 480 Mbps	1,8 m	333375
	USB 2.0 Extension Cable	A Male / A Female, Black, Bag	Extends a USB cable to a maximum of 5 m (16 ft.)	1,8 m	338653
	USB 2.0 Extension Cable	A Male / A Female, Black, Retail Blister	Extends a USB cable to a maximum of 5 m (16 ft.)	1,8 m	393843
				3 m	393850
	USB 2.0 Device Cable	A Male / Mini-B Male, Translucent Silver, Bag	Supports speeds of up to 480 Mbps	1,8 m	333412
	USB 2.0 Extension Cable	A Male / A Female, Translucent Silver, Bag	Extends a USB cable length	1,8 m	336314
				3 m	340496
				4,5 m	340502
	USB 2.0 Device Cable	Micro-A Male / Micro-B Male, Black, Bag	Supports speeds of up to 480 Mbps	1,8 m	307444
		Micro-A Male / Micro-A Male, Black, Bag		1,8 m	307468

	Name	Description	Main Feature	Length	Model #
HDMI Cables					
	High Speed Micro HDMI Cable With Ethernet Channel	Micro HDMI Male to Micro HDMI Male, Shielded, Black, Bag	Supports HD resolutions beyond 1080p and Deep Color	1 m	326636
	High Speed Mini HDMI Cable	Mini HDMI Male to Male, Shielded, Black, Bag	Supports HD resolutions beyond 1080p and Deep Color	1,8 m	305020
				5 m	305044
	High Speed HDMI Display Cable	HDMI Male to Male, Shielded, Black/Gray, Retail Blister	Supports HD resolutions beyond 1080p and Deep Color	1,8 m	391511
	High Speed HDMI Cable	3D, 4K, HDMI Male to Male, Shielded, Black, Bag	4K resolution supports video resolution beyond 1080p; up to 1080p resolution in 3D and Deep Color	1,8 m	306119
				3 m	306126
				5 m	306133
				7,5 m	308441
				10 m	322539
				15 m	308434
				22,5 m	308458
	High Speed HDMI Cable With Ethernet Channel	HEC, ARC, 3D, 4K, HDMI Male to Male, Shielded, Black, Bag	4K resolution supports video resolution beyond 1080p; up to 1080p resolution in 3D and Deep Color	2 m	323215
				3 m	323222
				5 m	323239
				10 m	323246
				15 m	323260
	High Speed HDMI Cable With Ethernet Channel	HEC, ARC, 3D, 4K, HDMI Male to Male, Shielded, Black, Retail Blister	4K resolution supports video resolution beyond 1080p; up to 1080p resolution in 3D and Deep Color	2 m	393751
				3 m	393768
	High Speed HDMI Cable with Ethernet Channel	HEC, ARC, 3D, 4K, HDMI Male to Micro Male, Shielded, Black, Retail Packaging	4K resolution supports video resolution beyond 1080p; up to 1080p resolution in 3D and Deep Color	2 m	390538





	Name	Description	Main Feature	Length	Model #
HDMI Cables cont.					
	High Speed HDMI Cable With Ethernet Channel	HEC, ARC, 3D, 4K, HDMI Male to Micro Male, Shielded, Black, Bag	4K resolution supports video resolution beyond 1080p; up to 1080p resolution in 3D and Deep Color	2 m	324427
	High Speed HDMI Cable	3D, 4K, Mini HDMI Male to HDMI Male, Shielded, Black, Bag	4K resolution supports video resolution beyond 1080p; up to 1080p resolution in 3D and Deep Color	1,8 m	304955
	HDMI Cable	HDMI Male to DVI-D 24+1 Male, Dual Link, Black, Bag	Connect between HDMI and DVI-D video source and display	1,8 m	372503
	DisplayPort Adapter	DisplayPort Male / HDMI Adapter Female, Bag	Converts a DisplayPort signal to an HDMI signal	N/A	308212
VGA Cables					
	SVGA Monitor Cable	HD15 Male / HD15 Male, Black, Retail Packaging	Connects SVGA source to SVGA display	1,8 m	390668
	SVGA Monitor Cable	HD15 Male / HD15 Male, Black, Retail Blister	Connects SVGA source to SVGA display	1,8 m	393775
				3 m	393782
	SVGA Monitor Cable	HD15 Male / HD15 Male, Black, Bag	Connects SVGA source to SVGA display	1,8 m	311731
				3 m	311748
				4,5 m	312721
				7,5 m	372978
				10 m	312776
				15 m	313629
				20 m	335607
30 m	337342				

	Name	Description	Main Feature	Length	Model #
VGA Cables cont.					
	SVGA Monitor Cable	HD15 Male / HD15 Male with Ferrite Cores, Black, Bag	Connects SVGA source to SVGA display	1,8 m	317757
				3 m	317733
				4,5 m	317719
				7,5 m	373708
				10 m	317696
				15 m	372183
				20 m	372190
				30 m	373715
	SVGA Extension Cable	HD15 Male / HD15 Female, Black, Bag	Extends any monitor cable	1,8 m	309011
				3 m	313599
				4,5 m	310345
				10 m	313605
	SVGA Extension Cable	HD15 Male / HD15 Female with Ferrite Cores, Black, Bag	Extends any monitor cable	1,8 m	317764
				3 m	317740
				4,5 m	317726
				7,5 m	373685
				10 m	317702
				15 m	372107
				20 m	371179
30 m	373692				
	SVGA with Audio Cable	HD15 and Stereo 3.5 mm Plug, Male to Male, Black, Bag	Ideal single-cable solution for connecting a computer to a monitor with built-in speakers	20 m	326681
	VGA Monitor Cable	HD15 Male / HD15 Male, Grey, Bag	Connects VGA source to VGA display	1,8 m	300735
				3 m	300926
	SVGA Y Cable	HD15 Male / 2 HD15 Female, Black, Bag	Splits SVGA connection between two monitors	15 cm	304559
	Video Splitter Cable	DVI-I Dual Link Male to VGA Female / RCA Female, Black, Bag	Connects a DVI-I male source with VGA female and RCA female displays	0,3 m	307871

	Name	Description	Main Feature	Length	Model #
DisplayPort Cables					
	DisplayPort Monitor Cable	DisplayPort Male / DisplayPort Male, Black, Bag	Delivers high-bandwidth, digital audio/visual signals from PC to display and other DisplayPort-enabled devices — up to 1080p resolution	1 m	306935
				2 m	307116
				3 m	307093
	DisplayPort Monitor Cable	DisplayPort Male / DisplayPort Male, Black, Retail Blister	Delivers high-bandwidth, digital audio/visual signals from PC to display and other DisplayPort-enabled devices — up to 1080p resolution	2 m	393799
				3 m	393805
	DisplayPort Adapter	DisplayPort Male / HDMI Adapter Female, Passive, Bag	Converts a DisplayPort signal to an HDMI signal	N/A	308212
	DisplayPort to VGA Converter Cable	DisplayPort Male to HD15 Female, Active, Black, Bag	Easily connects DisplayPort-equipped computers with VGA monitors, projectors and more	15 cm	325325
Mini-DisplayPort Cables					
	Mini-DisplayPort to VGA Adapter	Mini-DisplayPort Male to VGA Female, Active, Bag	Delivers a single, high-quality signal to VGA display – ideal for Mac computers	N/A	322508
	Mini-DisplayPort to HDMI Adapter	Mini-DisplayPort Male to HDMI Female, Passive, White, Bag	Delivers a single, high-quality signal to HDMI display – ideal for Mac computers	N/A	322461
	Mini-DisplayPort Monitor Cable	Mini-DisplayPort Male to DisplayPort Male, White, Bag	Delivers digital audio/visual signals from Mini DisplayPort and DisplayPort enabled displays and devices – up to 1080p resolution	1 m	324724
				2 m	324748
				3 m	324830
	Mini-DisplayPort Monitor Cable	Mini-DisplayPort Male to DisplayPort Male, White, Retail Blister	Delivers high-bandwidth, digital audio/visual signals from Mini DisplayPort and DisplayPort enabled displays and devices – up to 1080p resolution	2 m	393812

	Name	Description	Main Feature	Length	Model #
Mini-DisplayPort Cables cont.					
	Mini DisplayPort Monitor Cable	Mini DisplayPort, Male to Male, White, Bag	Delivers high-bandwidth, digital audio/visual signals from Mini-DisplayPort enabled devices to Mini-DisplayPort displays — up to 1080p resolution	1 m	324557
				2 m	324632
				3 m	324670
DVI Cables					
	Digital Video Cable	DVI-D Dual Link, Grey, Bag	DVI 24 male to DVI 24 male	1.8 m	328838
	HDMI Cable	HDMI Male to DVI-D 24+1 Male, Dual Link, Black, Bag	Connect between HDMI and DVI-D video source and display	1.8 m	372503
	Digital Video Adapter	DVI-I Dual Link Male to VGA Female, Grey, Bag	Fully shielded - ideal for all monitor sizes and types	N/A	328883
SATA Cables					
	SATA Data Cable	7-Pin Male to Male, Red, Bag	Supports data transfer speeds up to 6.0 Gbps	50 cm	340700
	Power Y Cable	5.25" Male to dual 5.25" Female, Bag	Converts a 4-pin Molex male to dual 4-pin Molex female connections	20 cm	301503
	SATA Power Cable	4 Pin to 15 Pin, Bag	Helps create additional power connections from existing sources	16 cm	342766
	SATA Power Y Cable	4 pin to 2 x 15 pin, Bag	Helps create additional power connections from existing sources	15 cm	349369

	Name	Description	Main Feature	Length	Model #
SATA Cables cont.					
	Internal SATA To External SATA Bracket	SATA To eSATA Bracket, 1 Port, Red, Bag	Creates an eSATA connection from the internal SATA controller	30 cm	300803
	eSATA+USB Cable	eSATA+USB Male to Type-A USB and eSATA Male, Black, Bag	Easily connects an eSATA+USB device to existing USB and eSATA ports	1 m	325301
Firewire Cables					
	IEEE 1394 Cables	4 pin to 4 pin, Black, Bag	For IEEE 1394 FireWire peripherals with power source	3 m	323772
				4,5 m	323789
	IEEE 1394 Cables	6 pin to 4 pin, Black, Bag	For IEEE 1394 FireWire peripherals with power source	3 m	323826
Power Cables					
	Power Cable	PC to Schuko, Black, Bag	Connects most desktop computers to Schuko outlets	1,8 m	300148
		PC to Schuko, Black, Retail Blister		1,8 m	391399
	Power Cable	PC to Schuko, Black, Retail Blister	Connects most desktop computers to Schuko outlets	1,8 m	393904
	Power Cable	C5 to Schuko, Black, Bag	Connects most notebook computers, power adapters and other electronic devices to Schuko outlets	1,8 m	371131
		C5 to Schuko, Black, Retail Packaging		1,8 m	391955
	Power Cable	Euro Version, Black, Bag	Connects most desktop computers to power outlets	1,8 m	339100
	Power Cable	Monitor to CPU, Black, Bag	Connects most monitors to a PC power supply – also serves as a power extension cable	1,8 m	301152

	Name	Description	Main Feature	Length	Model #
Network Cables					
	Network Cable, Cat5e, UTP	RJ45 Male / RJ45 Male, Black w/ Blue Boot, Retail Blister	PVC cable jacket for flexibility and durability	2 m	732642
				3 m	732659
				5 m	732932
Audio/Video Cables					
	Stereo Cable	3.5 mm stereo Male to Male, Black, Retail Blister	Heavy-gauge cable with PVC protective jacket	0,3 m	393928
				0,9 m	393935
	Stereo Audio Cable	3.5 mm Stereo Male to Male, Black, Bag	Heavy-gauge cable with PVC protective jacket	1,8 m	334594
	Stereo Y-Adapter	Stereo Y, 3.5mm Male to 2 x 3.5mm Female, Black, Retail Blister	Easily share a single audio output	15 cm	393942
iPhone/iPad/iPod Cables					
	iLynk USB Cable	A Male / 30-Pin Male, White, Retail Blister	Connects an iPod, iPhone or iPad to a USB port	1,2 m	391856
	iLynk AV Cable	Composite video, 30-pin connector, USB, White, Retail Blister	Connects an iPod, iPhone or iPad to the composite video inputs on a TV or stereo system	1,5 m	393713

Now Available:
Cable Essentials
in New Premium
Retail Blisters





NEW

1

[1] Zippack

- Made from heavy-duty, moisture-resistant material
- Comfortable, adjustable shoulder straps
- Padded inner sleeve fits and protects widescreen laptop computers up to 15.6"

Model Number: 439671 *Orange/Black*
 Model Number: 439688 *Blue/Black*
 Model Number: 439695 *Green/Black*
 Model Number: 439664 *Black/Black*



2



[2] Airpack

- Made from lightweight, moisture-resistant ripstop material
- Padded inner sleeve fits and protects widescreen laptop computers up to 15.6"

Model Number: 439718 *Blue/Black*
 Model Number: 439725 *Red/Black*
 Model Number: 439701 *Plum/Black*



3

[3] Olympian Notebook Computer Sportpack

- Separate notebook computer compartment offers improved protection and easy airport inspections
- Three spacious interior compartments and pockets store files, cables and accessories
- Adjustable chest and padded shoulder straps with padded back panel help disperse load for comfortable travel

Top Load, Fits Most Widescreens Up To 15.6"
 Model Number: 439473



4

[4] Copenhagen Netbook Computer Briefcase

- Functional, sensible design and styling for mobile professionals
- Practical solution that provides essential computer protection — travels almost anywhere and fits most netbook computers
- Large front and rear pockets store files, cables and accessories

Top Load; Fits Most Widescreens Up To 10.1"
 Model Number: 439480



5

[5] Empire Notebook Computer Briefcase

- Ultra-lightweight bag weighs only 35 oz.
- Padded compartment for notebook computer protection
- Multiple compartments for files and accessories

Top Load, Fits Most Widescreens Up To 17"
 Model Number: 421560



6

[6] Empire II Notebook Computer Briefcase

- Ultra-lightweight bag weighs only 40 oz.
- Padded compartment for notebook computer protection
- Multiple compartments for files and accessories

Top Load, Fits Most Widescreens Up To 15.6"
 Model Number: 421577

[7] Cologne Notebook Computer Briefcase

- Stylish blend of efficiency, organization and convenience for mobile professionals
- Large front pocket stores cables and accessories with handy mesh pocket for papers, tickets and more

Top Load, Fits Most Widescreens Up To 17"

Model Number: 438926

7



[8] Berlin Notebook Computer Messenger Sling Bag

- A modern, urban alternative to traditional notebook computer backpacks and briefcases
- Single shoulder sling strap with quick-release closure adjusts for comfortable fit

Top Load, Fits Most Widescreens Up To 14.1"

Model Number: 439541

Top Load, Fits Most Widescreens Up To 15.6"

Model Number: 439558

8



[9] Big Apple Notebook Computer Briefcase

- Large padded compartment with adjustable divider for notebook computer protection
- Ultra-lightweight weighs only 49 oz.
- Two front compartments, large notebook area and back expandable compartment with three file folders

Top Load, Fits Most Widescreens Up To 17"

Model Number: 433723

9



[10] Times Square Notebook Computer Briefcase

- Ultra-lightweight weighs only 30 oz.
- Padded compartment for notebook computer protection

Top Load, Fits Most Widescreens Up To 15.4"

Model Number: 421430

10



[11] Mobile Professional Set

- Value-packed duo takes mobile computing across town or around the globe
- Accurate USB optical mouse with three buttons and scroll wheel performs daily computing tasks

Top Load, Fits Most Widescreens Up To 15.6"

Model Number: 439527

11



[12] London Notebook Computer Briefcase

- Practical solution that provides essential computer protection — travels and fits almost anywhere
- Large front pocket stores files, cables and accessories

Top Load; Fits Most Widescreens Up To 15.6"

Model Number: 438889

Black

Model Number: 439381

Dark Citron

Model Number: 439374

Fuchsia Red

Top Load; Fits Most Widescreens Up To 12"

Model Number: 439589

Black

12



[1] Notebook Computer Cooling Stand

- Helps reduce operating temperatures for longer life and improved performance
- Quiet, high-volume lighted fan helps dissipate damaging heat
- Special ergonomic incline improves comfort and reduces repetitive strain injury risk

Model Number: 190046

[2] Notebook Computer Cooling Pad

- Helps reduce operating temperatures for longer life and improved performance
- Large, quiet, high-volume fan helps dissipate damaging heat
- USB pass-through connection keeps port available for other devices

Model Number: 703406

[3] Notebook Computer Cooler

- Helps reduce operating temperatures for longer life and improved performance
- Quiet, high-volume fan helps dissipate damaging heat
- Fits under any notebook computer – compact and lightweight for travel

Model Number: 140072

[4] Notebook Computer Cooling Pad

- Helps reduce operating temperatures for longer life and improved performance
- Three quiet, high-volume fans help dissipate damaging heat
- Fits under any notebook computer – compact and lightweight for travel

Model Number: 700467

[5] Notebook Computer Cooling Pad

- Helps reduce operating temperature for longer life and improved performance
- Two quiet, high-volume fans help dissipate damaging heat
- Stylish and functional design with special lighting effects

Model Number: 700429



[1] Power Adapter

- 7 selectable output levels provide a broad mobile power solution — 12 to 24 V
- Convenient, single AC power source for notebook computers and other portable devices

Model Number: 100854 70 W



[2] Universal Notebook Power Adapter

- 8 selectable output levels provide a broad mobile power solution — from 15 to 24 V
- 9 convertible plug tips ensure proper polarization and fit
- Built-in USB power port charges MP3 players, mobile phones and more
- Lightweight and compact design easily stores for travel — fits most car cigarette lighters and 12 V power ports

Model Number: 101615 100 W



[3] Universal Notebook Power Adapter

- Automatically selects among 6 voltage output levels to provide a broad mobile power solution — from 15 to 20 V
- Convenient, single power source for notebook computers and other portable devices
- 9 convertible plug tips ensure proper polarization and fit

Model Number: 101639 70 W



[4] Universal Notebook Power Adapter

- Automatically selects between 5 voltage output levels to provide a broad mobile power solution — from 15 V to 20 V
- Convenient, single power source with USB port for notebook computers and other portable devices
- 9 convertible plug tips ensure proper polarization and fit

Model Number: 101646 90 W, USB



[5] Universal Notebook Power Adapter

- Automatically selects among 7 voltage output levels to provide a broad mobile power solution — from 15 V to 20 V
- 9 convertible plug tips ensure proper polarization and fit

Model Number: 101684 90 W, USB, LCD

Model Number: 101691 120 W



101684

[6] Mini Notebook Power Adapter

- Automatically selects among 5 voltage output levels to provide a broad mobile power solution — from 9.5 to 20 V
- 5 convertible plug tips ensure proper polarization and fit

Model Number: 101622 40 W



[7] Notebook Power Adapter

- Universal AC input provides a broad, mobile power solution
- Convertible DC plug tips ensure proper polarization and fit

Model Number: 307888 19 V, AC/DC, 90 W

Model Number: 307895 19 V, AC/DC, 120 W





1

[1] Mobile Security Lock

- Helps deter theft of notebook computers and other valuable equipment
- Fits built-in security slot and secures to a desk or other stationary object
- Strong steel cable and solid, all-metal construction resist tampering

Model Number: 440240



2

[2] USB Power Adapter

- Rapidly charges USB devices using an AC power source
- Provides convenient, reliable charging when a USB port is unavailable
- Ideal for digital cameras, music players, cellular phones and other mobile devices

Model Number: 401494

Europlug C5



3

[3] USB Mobile Charger

- Converts 12 V into 5 V DC power for USB accessories
- Recharges USB and other portable devices including mobile phones, MP3 players and more
- Multiple circuit and surge protection prevents equipment damage and vehicle against backflow

Model Number: 401364



4

[4] Mobile Power Pack

- Convenient, rechargeable external backup power for mobile devices – including iPhone and iPod
- Provides up to 50 additional hours of power when conventional sources are unavailable
- Quickly recharges through any USB port

Model Number: 168267



5



438858

[5] USB Flex Light

- Adjusts to gently illuminate computer keyboard without disturbing others
- Ideal for airline cabins, meeting rooms, presentations and other low-light environments
- Lightweight for travel and easily installs into any USB port — no external power needed

LED provides task lighting for notebook computers

Model Number: 431644

Two LEDs provide task lighting for notebook computers

Model Number: 438858



6

[6] Cable FlexWrap

- Easy to use
- Protects equipment and cables
- Perfect for wire management

Model Number: 502962

[1] LCD Monitor Mount with Double-Link Swing Arms

- Securely holds two LCD monitors up to 24" and 15.4 pounds each
- Positions monitors above the desktop to increase work space, improve visibility and minimize clutter
- 36" double-link swing arms with separate 180° tilt and 180° rotation
- Meets VESA standards

Model Number: 420808



[2] LCD Monitor Pole

- Double-link swing arm optimizes ergonomics and monitor views with $\pm 15^\circ$ tilt, 360° swivel and height adjustments
- Durable steel and aluminum construction with heavy-duty clamp mounts to desktop or other horizontal surface
- Meets VESA standards – fits monitors from 13" to 27" and up to 15 kg (33 lbs.)

Model Number: 423786

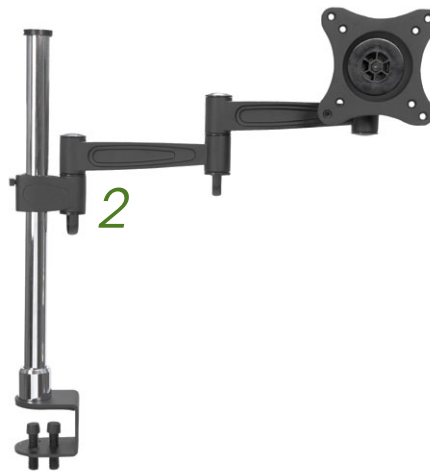

[3] LCD Wall Mount

- Securely holds one LCD monitor on wall to improve views, increase work space and minimize clutter
- Two-piece bracket with heavy-duty, steel construction easily mounts to most vertical surfaces
- Meets VESA standards — fits monitors up to 22" and up to 33 pounds

Model Number: 422840



[4] Monitor Wall Mount

- Securely holds one LCD monitor on wall to improve views, increase work space and minimize clutter
- Two-piece bracket with heavy-duty, steel construction easily mounts to most vertical surfaces
- Meets VESA standards — fits monitors up to 22" and up to 26 pounds

Model Number: 432351



[5] A/V Component Wall Shelves

- Securely holds DVD/Blu-ray player, receiver, set-top box, game console and more
- Modern tempered-glass design directly mounts on wall under flat-panel TVs
- Durable aluminum construction with cable management

Holds up to 8 kg (17.6 lbs.)

Model Number: 423656

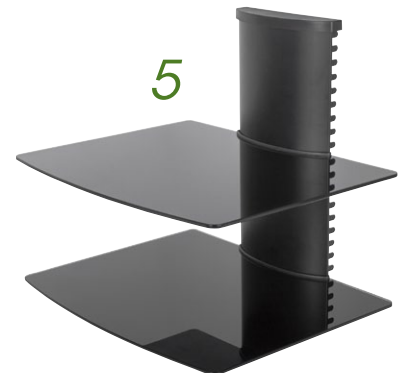



[6] A/V Dual Component Wall Shelves

- Securely holds a DVD/Blu-ray player, receiver, set-top box, game console and more
- Modern tempered-glass design directly mounts on a wall under flat-panel TVs
- Durable aluminum construction with cable management

Holds up to 8 kg (17.6 lbs.) per shelf

Model Number: 460767

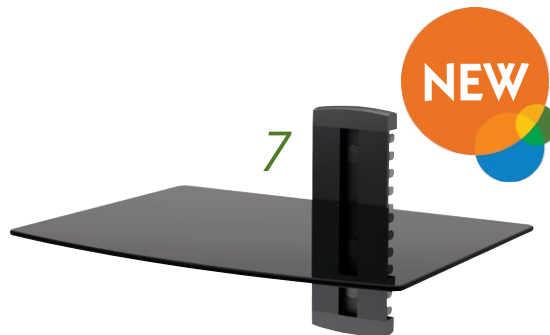

[7] A/V Component Wall Shelf

- Securely holds DVD/Blu-ray player, receiver, set-top box, game console and more
- Modern tempered-glass design directly mounts on a wall under flat-panel TVs
- Durable aluminum construction with cable management

Holds up to 8 kg (17.6 lbs.)

Model Number: 460750



[8] A/V Component Wall Shelf

- Securely holds a DVD/Blu-ray player, receiver, set-top box, game console and more
- Modern tempered-glass design directly mounts on a wall under flat-panel TVs
- Durable steel construction

Holds up to 8 kg (17.6 lbs.)

Model Number: 460781



[9] Universal Folding A/V Accessory Wall Mount

- Avoid accidental bumps or damage with its foldaway design
- Arms adjust to support housings 200-450 mm in width, 24-65 mm in height and up to 8 kg (17.6 lbs.)

Model Number: 460743

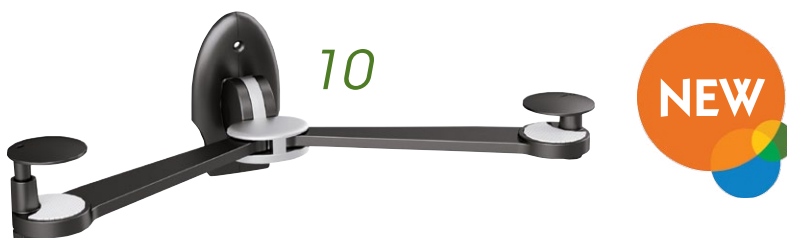

[10] Universal Folding A/V Wall Mount

- Avoid accidental bumps or damage with its foldaway design
- Arms adjust to support housings 200-450 mm in width, 25-45 mm in height and up to 3 kg (6.6 lbs.)

Model Number: 460736

[11] Universal Flat-Panel TV Articulating Wall Mount

- Optimize views with $\pm 15^\circ$ tilt and 180° swivel adjustments
- Durable aluminum construction
- Meets VESA standards — supports TVs from 13" to 27" up to 15 kg (33 lbs.)

Model Number: 423670 *Double arm*
 Model Number: 423700 *Single arm*



[12] Universal Flat-Panel TV Tilting Wall Mount

- Optimize views with -15° to 10° tilt adjustment
- Meets VESA standards — supports TVs from 13" to 32" up to 20 kg (44 lbs.)

Model Number: 423717

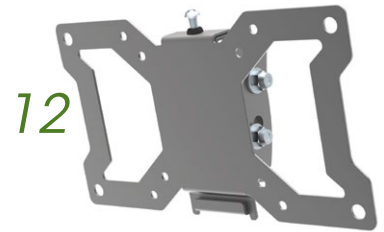

[13] Universal Flat-Panel TV Ultra Slim Wall Mount

- Ultra-low profile, fixed installation ideal for home, office and commercial applications - includes integrated bubble level
- Meets VESA standards - supports TVs from 23" to 42" up to 30 kg (66 lbs.)

Model Number: 423731



[14] Universal Flat-Panel TV Articulating Wall Mount

- Optimize views with $\pm 15^\circ$ tilt and 180° swivel adjustments
- Built-in cable management system and integrated bubble level
- Meets VESA standards - supports TVs from 23" to 42" up to 20 kg (44 lbs.)

Model Number: 423748 *Single arm*
 Model Number: 423755 *Double arm*



[15] Universal Flat-Panel TV Articulating Wall Mount

- Optimize views with $\pm 70^\circ$ tilt and $\pm 90^\circ$ swivel adjustments
- Built-in cable management system and integrated bubble level
- Meets VESA standards — supports TVs from 13" to 27" up to 15 kg (33 lbs.)

Model Number: 460958 *Double arm*
 Model Number: 460965 *Single arm*



[16] Universal Flat-Panel TV Ceiling Mount

- Optimize views with 0° to -15° tilt and 360° swivel adjustments
- Built-in security locking system protects against theft
- Meets VESA standards — supports TVs from 37" to 70" up to 50 kg (110 lbs.)

Model Number: 423625





[17] Universal Flat-Panel TV Low-Profile Wall Mount

- Low-profile, fixed installation ideal for home, office and commercial applications - includes integrated bubble level

Supports TVs from 37" to 70" up to 50 kg (110 lbs.)
Model Number: 424509

Supports TVs from 32" to 55" up to 40 kg (88 lbs.)
Model Number: 460934

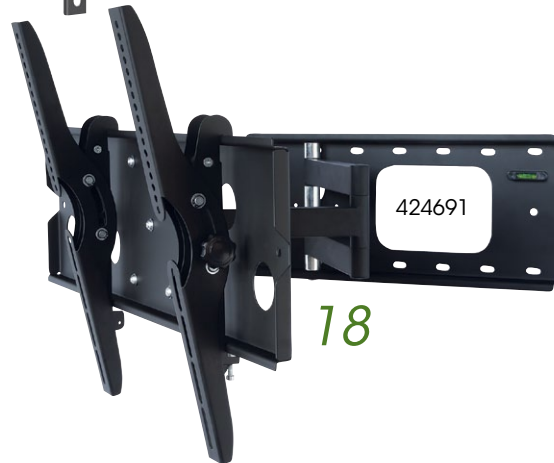

[18] Universal Flat-Panel TV Full-Motion Wall Mount

- Optimize views with full-motion $\pm 12^\circ$ tilt and 180° swivel adjustments
- Easy installation ideal for home, office and commercial applications - includes integrated bubble level

Supports TVs from 37" to 70" up to 40 kg (88 lbs.)
Model Number: 424691

Supports TVs from 32" to 55" up to 40 kg (88 lbs.)
Model Number: 424714



[19] Universal Flat-Panel TV Full-Motion Wall Mount

- Optimize views with full-motion $\pm 12^\circ$ tilt and 180° swivel adjustments
- Easy installation ideal for home, office and commercial applications - includes integrated bubble level
- Meets VESA standards - supports TVs from 37" to 70" up to 40 kg (88 lbs.)

Model Number: 424691

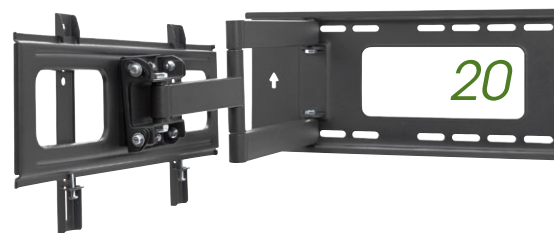

[20] Universal Flat-Panel TV Full-Motion Wall Mount

- Optimize views with -12° to 5° tilt and 180° swivel adjustment
- Easy installation ideal for home, office and commercial applications - includes integrated bubble level
- Meets VESA standards - supports TVs from 32" to 55" up to 40 kg (88 lbs.)

Model Number: 424714



[21] Universal Flat-Panel TV Tilting Wall Mount

- Optimize views with 0° to -14° tilt adjustment
- Easy installation ideal for home, office and commercial applications - includes bubble level
- Meets VESA standards - supports TVs from 32" to 55", 81-140 cm, up to 35 kg (77 lbs.)

Model Number: 460941

[22] Universal Flat-Panel TV Tilting Wall Mount

- Optimize views with $\pm 10^\circ$ tilt adjustment
- Easy installation ideal for home, office and commercial applications – includes integrated bubble level
- Meets VESA standards – supports TVs from 37" to 70" up to 75 kg (165 lbs.)

Model Number: 423830



[23] Universal Flat-Panel TV Tilting Wall Mount

- Optimize views with 0° to -10° tilt adjustment
- Easy installation ideal for home, office and commercial applications – includes integrated bubble level
- Meets VESA standards – supports TVs from 37" to 70" up to 75 kg (165 lbs.)

Model Number: 424752



[24] Universal Projector Ceiling Mount

- Securely holds most projectors up to 10 kg (22 lbs.)
- Optimize views with $\pm 10^\circ$ tilt, 360° swivel and height adjustments
- Durable aluminum construction with extension rod and cable management

Adjusts 13 to 106 cm (5 to 41.7 in.)

Model Number: 424820

Adjusts 57.5 to 82.5 cm (22.5 to 32 in.)

Model Number: 424837



[25] Universal Projector Ceiling Mount

- Securely holds most projectors up to 20 kg (44 lbs.)
- Optimize views with $\pm 20^\circ$ tilt and 360° swivel adjustments
- Easy installation ideal for home, office and commercial applications

Adjusts 57.5 to 82.5 cm (22.6 to 32.5 in.)

Model Number: 424851

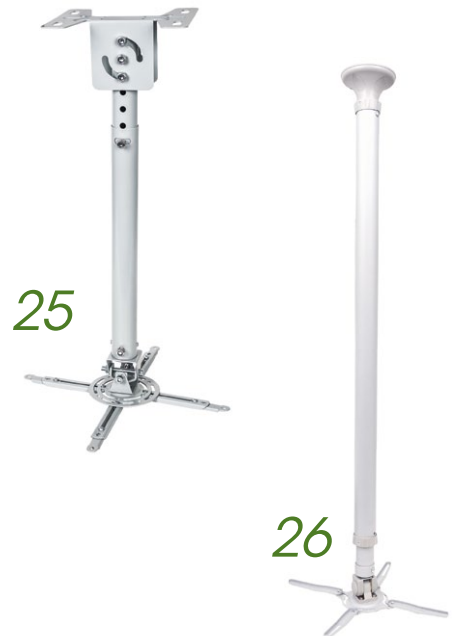

[26] Universal Projector Ceiling Mount

- Securely holds one projectors up to 15 kg (33 lbs.)
- Optimize views with $\pm 180^\circ$ tilt, 360° swivel and height adjustments
- Durable steel construction with extension rod and cable management

Adjusts 122 to 202 cm (48 to 79.5 in.)

Model Number: 424868



[1] LCD Cleaning Kit

- Safe for use on LCD surfaces — helps restore and maintain brightness and clarity
- Ideal for use with flat panel displays, notebook computers, handheld devices, keyboards and more
- Soft brush gently eliminates excess dust and debris without scratching

Model Number: 421027



[2] LCD Mini Cleaning Kit

- Safe for use on LCD surfaces - helps restore and maintain brightness and clarity
- Ideal for use with flat panel displays, notebook computers, televisions and more
- Soft brush gently eliminates excess dust and debris without scratching

Model Number: 421010



[3] LCD Cleaning Kit

- Ideal for use with flat panel displays, notebook computers, handheld devices and more
- Non-aerosol, gel cleaner with pleasant fragrance removes fingerprints and smudges without harsh solvents
- Soft, lint-free anti-microbial microfiber cloth cleans, dries and polishes for a clear, non-streak finish

Model Number: 404198

Jasmine Scent

Model Number: 404204

Green Apple Scent

Model Number: 404310

Lavender Scent

Model Number: 423540

Unscented



[4] LCD Cleaning Kit

- Special design commemorates international football championship
- Safe for use on LCD surfaces — helps restore and maintain brightness and clarity
- Ideal for use with larger flat-panel displays, widescreen notebook computers, televisions and more

Model Number: 423168



[5] Air Duster

- Gently removes dust and debris from sensitive electronics without scratching or residue - contains no CFC, FCKW or CKW
- Ideal for use with flat-panel displays, notebook computers, keyboards, camera and projector lenses and more
- Easily cleans power supply units, coolers and fans for improved efficiency and performance

One 400 ml (13.5 oz.) Can

Model Number: 156141

[1] Basic Computer Tool Kit

- Anti-static chip inserter, anti-static chip extractor, anti-static three-prong parts and chip retriever/extractor, anti-static chip tweezers
- 1/4" nutdriver
- 3/16" nut driver
- T-15 star-type screwdriver
- #1 Phillips screwdriver, #0 Phillips screwdriver
- 3/16 slotted screwdriver, 1/8" slotted screwdriver
- Extra parts tube
- Vinyl zipper case

Model Number: 400077



1

[2] Technician Tool Kit

- Soldering iron, solder wick and solder
- Anti-static chip inserter, anti-static chip extractor, anti-static three-prong parts and chip retriever/extractor, anti-static chip tweezers
- Needle nose pliers
- Extra parts tube
- 1/4" nut-driver
- 3/16" nut-driver
- T10 & T15 torque screwdriver
- (2) Phillips head screwdrivers, small and standard
- (2) Slotted/flat screwdrivers, small and standard

Model Number: 530071



2

[3] The Ultimate Tool Kit

- Includes: Remote cable tester, Digital multimeter, Fish tape, 50 ft., RJ-45 crimp/cut tool, Impact punch down tool, Disposable punch down tool, Slip-joint pliers, Adjustable wrench, Long needle-nose pliers, Wire cutters, Coaxial cable stripper, Surface cutter, Scissors, Electrical tape, Measuring tape, Utility knife, Cable stripper, Flat blade screwdriver, Phillips head screwdriver, 2 x 25 ft. of Cat5 cable and Rugged and stylish metal carrying case

Model Number: 110006



3

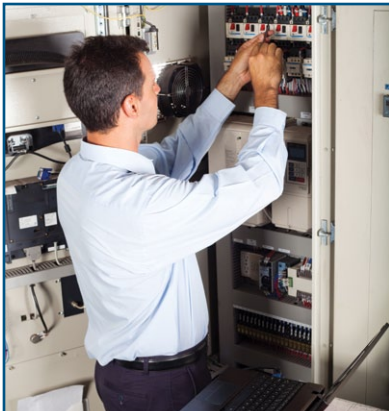

Must Have For Computer, Home and Office Repairs

Computer repair amateurs and professionals will find everything they need in these tool kits. The tools are organized in durable cases and include items such as screwdrivers, anti-static chip inserters, anti-static chip extractors, anti-static three-prong parts and chip retriever/extractors, anti-static chip tweezers, and much more. The Manhattan® Tool Kits are perfect for professional and amateur repairmen alike.



[1] Wrist-Rest Mouse Pad

- Soft wrist support feels like gel
- Ergonomically designed
- Non-slip base

Model Number: 434362

Black

Model Number: 434386

Blue



[2] Ergonomic Gel Mouse Pad

- Gel material promotes proper hand and wrist position – helps reduce wrist stress and repetitive motion disorders
- Helps fully utilize high mouse resolutions for more accurate response
- Low-friction surface provides effortless, comfortable movement

Model Number: 427203



[3] Ergonomic Mouse Pad

- Special design commemorates international football championship
- Promotes proper hand and wrist movement – helps reduce wrist stress and repetitive motion disorders
- Helps fully utilize high mouse resolutions for more accurate response

Model Number: 423182



[4] Mouse Pad Counter Display

- Sturdy, attractive display helps generate quick point-of-purchase revenue
- Pre-packed with 24 Manhattan Mouse Pads ready for sale
- Each mouse pad imprinted with a vibrant, full-color National Geographic image

National Geographic Collection, 24 pieces

Model Number: 423373



[1] Kickstand Case for the iPad mini

- Personalizes and protects your iPad mini
- Vegan leather cover and microsuede lining help prevent damage with an upscale look
- Interior pocket keeps your iPad mini secure with full access to display, controls and ports

Model Number: 404815



1

[2] iPad Slip-Fit Sleeve

- Personalizes and helps protect iPad tablets – ideal for iPad 2 and 3rd generation models
- Soft, textured finish adds a safe, assured grip to smooth iPad surfaces
- Snug, wraparound fit with full access to display, controls and ports

Model Number: 450027 *Black*
 Model Number: 450034 *Bright Blue*
 Model Number: 450041 *Frost*
 Model Number: 450201 *Blue/Red*
 Model Number: 450218 *Red/Blue*



2

[3] Leather Folio Case for the iPad (2/3/4 Gen.)

- Personalizes and protects your iPad (iPad 2, 3rd and 4th generation)
- Genuine leather cover and scratch-proof microsuede lining prevent damage and offer a professional, upscale look
- Interior pocket keeps your iPad secure with full access to display, controls and ports

Model Number: 450225



3

[4] Kickstand Case for the iPad (2/3/4 Gen.)

- Personalizes and protects your iPad (iPad 2, 3rd and 4th generation)
- Integrated stand places your iPad at optimal typing, reading and viewing positions
- Interior pocket keeps your iPad secure with full access to display, controls and ports

Model Number: 450249



4

[5] iPad Bluetooth Keyboard Case

- Personalizes and helps protect iPad tablets
- Built-in, full-function Bluetooth keyboard creates a wireless workstation almost anywhere
- Interior pocket keeps iPad secure with full access to display, controls and ports

Model Number: 450263



5





6

[6] iPad Gripper

- Unique, dimple pattern and hand strap add a safe, assured grip to smooth iPad surfaces
- Versatile design has convenient hand strap with full access to display, controls and ports
- Personalizes and helps protect iPad tablets – ideal for iPad 2 or 3 models
- Tough, rigid exterior with scratch-proof microsuede lining prevents minor damage

Model Number: 404624



7

[7] iPad Snap-Fit Shell

- Personalizes and protect iPad (3rd generation) tablets
- Tough, rigid exterior with scratch-proof microsuede lining prevents minor damage

Model Number: 404662 *Carbon Fiber*

Model Number: 404679 *Smoke*

Model Number: 404693 *Transparent Blue*



8

[8] iPad Snap-Fit Shell

- Personalizes and helps protect iPad tablets – ideal for iPad 2 models
- Tough, rigid exterior with scratch-proof microsuede lining prevents minor damage

Model Number: 450256 *Carbon Fiber*

Model Number: 450287 *Smoke*

Model Number: 450294 *Crystal*



9

[9] iPad Pouch

- Snug, cushioned fit stretches for added protection from daily mishandling and spills
- Coordinated, two-in-one design easily reverses to display alternate color

Model Number: 439503 *Purple/Beige*



10

[10] Tablet Bubble Case

- Designed to fit your iPad, or any other tablet with up to a 10.1-inch display
- Inner divider provides protection for your screen
- Convenient elastic stylus holder

Model Number: 439633 *Black/Orange*

Model Number: 439626 *Black/Blue*

Model Number: 439619 *Black/Yellow*

Model Number: 439602 *Black/Pink*

Model Number: 439596 *Black/Green*



11

[11] CrystalFilm SR

- Transparent film helps protect the screen of your device
- Protects against scratches and reduces fingerprints
- Maintains screen resolution, color, brightness and touch sensitivity

Model Number: 404853 *For Your iPad (2nd, 3rd and 4th generations)*

Model Number: 404877 *For Your iPad mini*

Model Number: 404891 *For Your iPhone 5, 5c and 5s*

404853

[12] Folio Case for Kindle Fire HD 7"

- Personalizes and helps protect Kindle Fire 7" tablets
- Vegan leather cover and microsuede lining help prevent damage with an upscale look
- Interior fasteners keeps tablet secure with full access to display, controls and ports

Model Number: 404839



12

[13] Acer Iconia A500 Slip-Fit Sleeve

- Personalizes and helps protect Acer Iconia A500 tablets
- Snug, wraparound fit with full access to display, controls and ports

Model Number: 451178 *Bright Blue*

Model Number: 451185 *Black*



13

[14] Samsung Galaxy 10.1 Slip-Fit Sleeve

- Personalizes and helps protect Samsung Galaxy 10.1 tablets
- Textured finish adds a safe, assured grip to smooth Galaxy 10.1 surfaces
- Snug, wraparound fit with full access to display, controls and ports

Model Number: 453684 *Clear/Black*



14

[15] Universal Tablet Stand

- For use with most major tablet brands
- A-frame design accommodates horizontal or vertical viewing positions
- Adjustable, non-skid base allows for multiple viewing angles
- Built-in rubber mount holds tablet firmly in place

Model Number: 453691



15

[16] Travel Tablet Stand

- For use with all major tablet brands
- A-frame design accommodates portrait or landscape viewing positions
- Adjustable, non-skid base
- Built-in rubber mount holds tablet firmly in place
- Compact size ideal for use anywhere

Model Number: 405973



16

[17] Capacitive Stylus Pen

- Dual-function design allows use as a stylus or a pen
- Ultra responsive capacitive stylus that works with all capacitive screens
- Scratch-resistant tip reduces screen smudges and fingerprints
- Refillable ink cartridge

Model Number: 404600 *Black/Silver*

Model Number: 404617 *Silver*



17

Point-of-Sale Concepts **Perfect for Retail**

Ideal to Showcase Products and Boost Sales



The Shuttle



The Ellipse



The Premium Kit



Sample Planogram

Please check with your account manager for details.



[1] Pegwall Gondola Display Shelf

- Easily adjust height and position to accommodate product displays

Model Number: 813228



[2] Pegwall Gondola Display Shelf Fence

- Easily installs onto Display Shelf (813228) to arrange and organize product presentations

Model Number: 813525

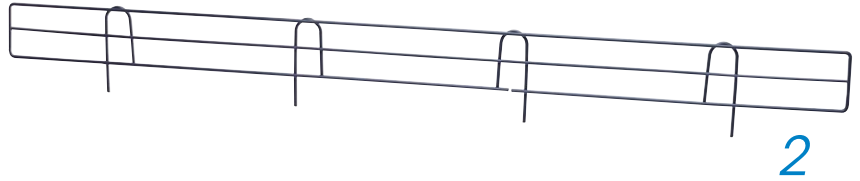

[3] Pegwall Gondola Display Hanger Bar with Arms

- Dual arms slide or detach to accommodate product displays

Model Number: 813266



[4] Pegwall Gondola Display Loop Hook

- 40 Hooks
- Open-back design easily installs into pegwall to arrange and organize hanging displays

Model Number: 813235 15 cm (6 in.)

Model Number: 813242 20 cm (8 in.)

Model Number: 813259 25 cm (10 in.)

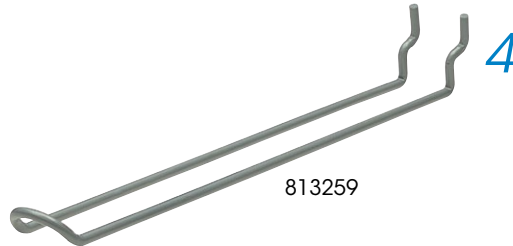

[5] Pegwall Gondola Hanger Arm

- Slides or detaches to accommodate product displays

Model Number: 813273

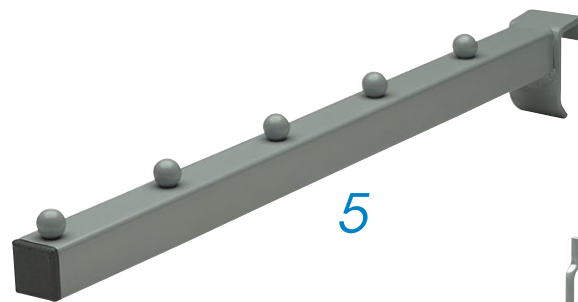

[6] Pegwall Gondola Display Brochure Holder

- Open-back design easily installs into pegwall to arrange and organize hanging displays

Model Number: 813289





7

[7] Pegwall Gondola Display Connector Cap

- Secures two Pegwall Gondola Display units when installed back-to-back
- Helps keep multi-unit displays steady and prevent tipping
- Ideal accessory for Pegwall Gondola Display Starter Kit (813501)

Model Number: 813211



8

[8] Pegwall Gondola Display Sign

- Fits into Pegwall Gondola Display header frame under light reflector to generate attention and create brand awareness

Model Number: 813198

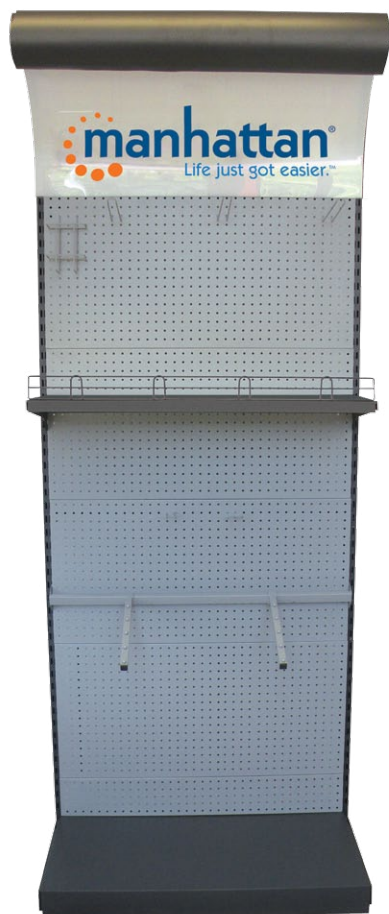

9

[9] Pegwall Gondola Display Starter Kit

- Modular design allows installation of multiple units for impressive retail displays
- Includes header frame and light reflector to generate attention and create brand awareness
- Optional shelves, hangers, hooks and accessories help present and organize merchandise for quick sale

Model Number: 813501



10

[10] Notebook Computer Case Floor Display

- Adjustable, triple-arms and tubular steel construction hold a broad range of Manhattan notebook computer cases
- Three-panel card frame focuses retail message to quickly generate sales
- Wide, lightweight base helps keep display steady and cases ready to sell

Model Number: 813334

Model Number	Page	Model Number	Page	Model Number	Page
100762	48	161510	43	178280	37
100854	68	161527	43	178297	37
100915	49	161534	38	178303	37
100939	49	161541	43	178310	37
100984	45	161558	43	178327	37
101615	68	161565	43	178334	37
101622	68	161572	45	178341	37
101639	68	161626	43	178358	37
101646	68	161633	43	178433	42
101653	48	161657	43	178488	41
101660	49	161664	39	178495	41
101677	49	161671	39	178617	41
101684	68	161695	39	178693	34
101691	68	161701	39	178709	34
101707	49	161718	45	178716	34
110006	76	161725	40	178747	34
130004	50	161732	40	178754	34
130042	51	161749	40	178761	34
130103	51	161923	38	179027	47
130110	51	164429	36	179133	33
130219	50	168267	69	179195	47
130226	50	170598	54	179225	46
130271	50	171557	52	179300	48
130288	51	172844	42	190046	67
130295	51	172844	49	201124	21
130349	51	174947	46	205146	46
130356	50	175135	32	205153	46
130363	50	175517	36	207331	32
130370	50	175524	36	207348	32
140072	67	175555	36	207355	32
150095	33	175586	52	211048	21
150125	40	175708	29	220064	17
150248	48	176354	30	220071	17
150439	46	176767	54	220088	17
150491	52	177009	28	220095	17
150682	53	177016	28	220125	17
150705	47	177146	32	220149	17
150712	48	177207	32	220163	17
150859	33	177269	32	300148	63
150958	48	177337	32	300735	60
150965	54	177344	32	300803	63
151047	46	177351	33	300926	60
151054	46	177436	29	301152	63
151061	47	177481	36	301503	62
151238	55	177603	42	304559	60
151245	55	177627	28	304955	59
151252	55	177658	28	305020	58
151269	55	177672	41	305044	58
151405	54	177689	27	306119	58
154109	54	177696	27	306126	58
156141	75	177702	27	306133	58
158152	52	177719	27	306935	61
158169	52	177726	27	307093	61
158176	53	177733	27	307116	61
158206	52	177757	27	307178	56
158213	52	177788	29	307444	57
158220	53	177795	28	307468	57
158251	53	177870	29	307871	60
158282	54	177887	30	307888	68
160353	53	177917	29	307895	68
160513	53	177955	28	308212	59
160599	44	177962	28	308212	61
160605	44	177979	28	308434	58
160612	44	177993	28	308441	58
160766	43	178013	28	308458	58
161022	45	178044	36	309011	60
161039	44	178136	34	310345	60
161053	43	178150	34	311731	59
161107	40	178167	34	311748	59
161169	44	178198	27	312721	59
161336	33	178211	42	312776	59
161367	38	178235	27	313001	16
161428	38	178259	37	313018	16
161435	39	178266	37	313025	16
161503	43	178273	37	313032	16

Model Number	Page	Model Number	Page	Model Number	Page
313056	16	317740	60	323215	58
313063	16	317757	60	323222	58
313070	16	317764	60	323239	58
313087	16	318082	16	323246	58
313094	16	318129	16	323260	58
313100	16	318143	16	323772	63
313117	16	318167	16	323789	63
313124	16	318198	16	323826	63
313148	17	318228	16	324427	59
313155	17	318921	16	324557	62
313162	17	318938	16	324632	62
313179	17	318945	16	324670	62
313377	16	318952	16	324724	61
313384	16	318969	16	324748	61
313391	17	318976	16	324830	61
313407	17	318983	16	325165	16
313414	17	318990	16	325301	63
313421	17	319300	16	325325	61
313438	17	319744	16	325417	56
313445	17	319768	16	325424	56
313452	17	319775	16	325677	56
313599	60	319782	16	325899	18
313605	60	319799	16	325936	16
313612	60	319805	16	325943	16
313629	59	319812	16	325950	16
313841	17	319829	16	325967	16
313858	17	319836	16	325974	16
313865	17	319843	16	325981	16
313872	17	319850	16	325998	16
313883	16	319867	16	326001	16
313889	17	319874	16	326018	16
313902	17	319881	16	326032	18
313919	17	319898	16	326636	58
314367	17	319966	16	326681	60
314374	17	319973	16	327749	18
314480	17	319980	16	328838	62
314497	17	319997	16	328883	62
314527	17	320368	16	329880	16
314619	17	320375	16	329897	16
314626	17	320399	16	329903	16
314886	17	320405	16	329910	16
314893	17	320429	16	329927	16
314909	17	320443	16	329934	16
314916	17	320603	16	329941	16
314923	17	320610	16	329958	16
314930	17	320627	16	329965	16
314947	17	320634	16	329972	16
315333	17	320641	16	329989	16
315340	17	320658	16	329996	16
315364	17	320665	16	330237	17
315371	17	320672	16	330282	17
315388	17	320689	16	330299	17
315395	17	320696	16	330305	17
315401	17	320702	16	330312	17
315715	17	320719	16	330336	16
315722	17	320726	16	330350	16
315739	17	320733	16	330367	16
315746	17	320740	16	330398	16
315753	17	320757	16	330442	16
315760	17	320764	16	330459	16
315777	17	320771	16	330466	16
316019	17	320788	16	330473	16
316026	17	320795	16	330480	16
316057	17	320801	16	330497	16
316064	17	321785	17	330503	16
316415	17	321792	17	330510	16
316422	17	321822	17	330527	16
316439	17	321998	16	330534	16
317016	46	322379	56	330541	16
317474	46	322430	56	330558	16
317696	60	322447	56	330565	16
317702	60	322454	56	330572	16
317719	60	322461	61	330589	16
317726	60	322508	61	330596	16
317733	60	322539	58	330602	16

Model Number	Page	Model Number	Page	Model Number	Page
330619	16	334594	64	342209	16
330626	16	335607	59	342216	16
330633	16	335645	16	342223	16
330640	16	335836	16	342230	16
330657	16	336314	57	342247	16
330664	16	336581	46	342254	16
330671	16	336628	16	342261	16
330688	16	336666	16	342278	16
330695	16	336673	16	342292	16
330701	16	336734	16	342308	16
330718	16	336741	16	342322	16
330725	16	336758	16	342339	16
330732	16	336765	16	342346	16
330749	16	336772	16	342353	16
330756	16	337212	16	342360	16
330763	16	337342	59	342377	16
330770	16	337892	18	342391	16
330787	16	338288	16	342407	16
330794	16	338295	16	342414	16
330800	16	338301	16	342421	16
330817	16	338318	16	342438	16
330824	16	338325	16	342445	16
330831	16	338332	16	342452	16
330848	16	338370	16	342469	16
330855	16	338387	16	342476	16
330862	16	338394	16	342483	16
331524	16	338400	16	342490	16
331791	16	338417	16	342506	16
331814	16	338424	16	342520	16
331821	16	338455	16	342537	16
331838	16	338585	17	342544	16
331845	16	338653	57	342551	16
331852	16	338929	17	342568	16
331869	16	339100	63	342575	16
331876	16	340373	16	342582	16
331890	16	340380	16	342599	16
331906	16	340427	16	342605	16
331913	16	340458	57	342629	16
331937	16	340496	57	342636	16
331944	16	340502	57	342766	62
331951	16	340557	16	342797	17
331968	16	340700	62	342803	17
331975	16	341165	18	343305	16
331982	16	341264	17	343350	16
332002	16	341271	17	343367	16
332019	16	341288	17	343718	16
332026	16	341295	17	343725	16
332033	16	341301	17	343732	16
332040	16	341325	17	343749	16
332057	16	341332	17	343756	16
332064	16	341349	17	343763	16
332071	16	341509	16	343770	16
332088	16	341936	16	343787	16
332095	16	341943	16	343794	16
332101	16	341950	16	343800	16
332118	16	341967	16	343817	16
332125	16	341974	16	343978	17
332132	16	341998	16	343985	17
332385	16	342001	16	343992	17
332392	16	342025	16	344005	17
332408	16	342032	16	344012	17
332415	16	342049	16	344029	17
332545	16	342056	16	344036	17
332552	16	342063	16	344043	17
332569	16	342070	16	344050	17
333078	18	342094	16	344067	17
333368	56	342100	16	344074	17
333375	57	342117	16	344081	17
333382	56	342124	16	344098	17
333405	57	342131	16	344104	17
333412	57	342148	16	344111	17
334112	16	342155	16	344128	17
334129	16	342162	16	344135	17
334136	18	342179	16	344142	17
334143	18	342193	16	344159	17

Model Number	Page	Model Number	Page	Model Number	Page
344166	17	391511	58	404891	79
344173	17	391856	64	405973	80
344180	17	391863	56	420808	70
344197	17	391955	63	421010	75
344203	17	392648	17	421027	75
344210	17	392655	17	421430	66
344227	17	392662	17	421560	65
344234	17	392679	17	421577	65
344241	17	392686	17	422840	70
344333	17	392693	17	423168	75
344340	17	392754	16	423182	77
344357	17	392761	16	423373	77
344364	17	392778	16	423540	75
344371	17	392785	16	423625	72
344388	17	392792	16	423656	70
344395	17	392808	16	423670	72
344524	17	392815	16	423700	72
344531	17	392822	16	423717	72
344548	17	392884	17	423731	72
344555	17	392891	17	423748	72
344562	17	392907	17	423755	72
344579	17	392914	17	423786	70
344586	17	392921	17	423830	74
344593	17	392938	17	424509	73
344609	17	392945	17	424691	73
344616	17	392952	17	424691	73
344623	17	393119	16	424714	73
344630	17	393126	16	424714	73
344647	17	393133	16	424752	74
344654	17	393140	16	424820	74
344661	17	393157	16	424837	74
345033	16	393164	16	424851	74
345040	16	393171	16	424868	74
345057	16	393188	16	427203	77
345064	16	393225	17	431644	69
345378	16	393256	56	432351	70
345385	16	393294	17	433723	66
345408	57	393713	64	434362	77
347440	16	393737	57	434386	77
347648	17	393751	58	438858	69
347655	17	393768	58	438889	66
347662	17	393775	59	438926	66
347679	17	393782	59	439374	66
347686	17	393799	61	439381	66
347693	17	393805	61	439473	65
347709	17	393812	61	439480	65
347716	17	393829	57	439503	79
347723	17	393836	57	439527	66
347730	17	393843	57	439541	66
347747	17	393850	57	439558	66
347754	17	393867	56	439589	66
347761	17	393874	56	439596	79
347778	17	393881	56	439602	79
348188	16	393898	56	439619	79
349369	62	393904	63	439626	79
350310	45	393928	64	439633	79
351898	21	393935	64	439664	65
351911	21	393942	64	439671	65
362320	18	400077	76	439688	65
371131	63	401364	69	439695	65
371179	60	401494	69	439701	65
372107	60	401517	41	439718	65
372183	60	404198	75	439725	65
372190	60	404204	75	440240	69
372503	59	404310	75	450027	78
372503	62	404600	80	450034	78
372978	59	404617	80	450041	78
373685	60	404624	79	450201	78
373692	60	404662	79	450218	78
373708	60	404679	79	450225	78
373715	60	404693	79	450249	78
390231	57	404815	78	450256	79
390538	58	404839	80	450263	78
390668	59	404853	79	450287	79
391399	63	404877	79	450294	79

Model Number	Page	Model Number	Page	Model Number	Page
451178	80	460767	71	524728	2
451185	80	460781	71	524735	2
451307	16	460835	41	524827	3
451406	16	460842	42	524988	3
451505	16	460866	41	524995	4
451604	16	460934	73	525176	4
451703	16	460941	73	525206	4
451901	16	460958	72	525251	2
452007	16	460965	72	525268	3
452922	16	500395	6	525275	4
452939	16	500425	6	525299	2
452946	16	500449	5	525466	24
452953	16	500494	21	525473	23
452960	16	502023	7	525480	24
452977	16	502290	5	525497	2
452984	16	502306	5	525503	23
452991	16	502313	5	525510	23
453004	16	502344	20	525527	24
453059	16	502399	20	525534	24
453066	16	502900	10	525572	24
453073	16	502931	11	525602	24
453080	16	502962	69	530071	76
453097	16	504195	20	530347	9
453103	16	504225	20	530378	9
453110	16	504768	20	545006	13
453127	16	504775	20	550857	14
453141	16	505451	15	550956	14
453189	16	505598	15	551069	14
453196	16	505727	12	551090	15
453202	16	505734	12	551106	14
453219	16	505895	15	551113	14
453226	16	506441	12	551366	14
453233	16	506496	12	551380	15
453240	16	506502	13	551397	15
453257	16	506519	13	551410	15
453264	16	506533	13	551441	15
453271	16	506663	26	560283	19
453318	16	506670	26	560443	10
453325	16	506724	13	560535	11
453332	16	506731	26	560542	11
453349	16	506847	26	560559	11
453356	16	506892	26	560566	10
453363	16	509510	12	560665	10
453370	16	510424	47	560689	26
453387	16	512008	20	560696	26
453394	16	513555	19	560702	26
453448	16	513579	19	560757	10
453455	16	515566	21	560764	10
453462	16	518130	18	560771	11
453479	16	519779	48	560801	9
453486	16	520409	7	560818	9
453493	16	520416	8	560849	11
453509	16	520959	19	600040	17
453516	16	521413	5	600226	17
453530	16	522137	6	601022	17
453579	16	522144	6	603102	17
453585	16	522175	6	603119	17
453592	16	522328	12	603126	17
453608	16	522533	12	603133	17
453615	16	522595	7	603157	17
453622	16	523301	7	603164	17
453639	16	523318	7	603171	17
453646	16	523929	8	603188	17
453653	16	523974	4	603195	17
453660	16	524018	5	603201	17
453684	80	524025	6	603218	17
453691	80	524117	8	603225	17
460255	42	524124	8	604208	17
460507	31	524148	9	604215	17
460514	31	524162	9	604246	17
460545	31	524179	10	604253	17
460729	31	524353	12	604260	17
460736	71	524698	4	604277	17
460743	71	524704	2	622082	17
460750	71	524711	3	623773	17

Model Number	Page	Model Number	Page	Model Number	Page
634588	17	733540	17	734295	17
634618	17	733557	17	734301	17
634632	17	733564	17	734318	17
634656	17	733571	17	734325	17
634670	17	733588	17	734332	17
634687	17	733595	17	734349	17
634700	17	733601	17	734356	17
634755	17	733618	17	734363	17
634793	17	733625	17	734370	17
634809	17	733632	17	734387	17
634816	17	733649	17	734394	17
634823	17	733656	17	734400	17
634878	17	733663	17	734417	17
634915	17	733670	17	734424	17
634922	17	733687	17	734431	17
635202	17	733694	17	734448	17
636599	17	733700	17	734455	17
700429	67	733717	17	734462	17
700467	67	733724	17	734479	17
701662	50	733731	17	734486	17
703406	67	733748	17	734493	17
704663	18	733755	17	734509	17
720038	19	733762	17	734516	17
730402	16	733779	17	734523	17
732642	64	733786	17	734530	17
732659	64	733793	17	734547	17
732932	64	733809	17	734554	17
733069	17	733816	17	734561	17
733076	17	733823	17	734578	17
733083	17	733830	17	734585	17
733090	17	733847	17	734592	17
733106	17	733854	17	790055	20
733113	17	733861	17	790291	6
733120	17	733878	17	790338	5
733137	17	733885	17	790406	6
733144	17	733892	17	813198	83
733151	17	733908	17	813211	83
733168	17	733915	17	813228	82
733175	17	733922	17	813235	82
733182	17	733939	17	813242	82
733199	17	733946	17	813259	82
733205	17	733953	17	813266	82
733212	17	733960	17	813273	82
733229	17	733977	17	813289	82
733236	17	733984	17	813334	83
733243	17	733991	17	813501	83
733250	17	734004	17	813525	82
733267	17	734011	17	993883	18
733274	17	734028	17	993890	18
733281	17	734035	17	993906	18
733298	17	734042	17	993913	18
733304	17	734059	17	993920	18
733311	17	734066	17		
733328	17	734073	17		
733335	17	734080	17		
733342	17	734097	17		
733359	17	734103	17		
733366	17	734110	17		
733373	17	734127	17		
733380	17	734134	17		
733397	17	734141	17		
733403	17	734158	17		
733410	17	734165	17		
733427	17	734172	17		
733434	17	734189	17		
733441	17	734196	17		
733458	17	734202	17		
733465	17	734219	17		
733472	17	734226	17		
733489	17	734233	17		
733496	17	734240	17		
733502	17	734257	17		
733519	17	734264	17		
733526	17	734271	17		
733533	17	734288	17		

Manhattan and Intellinet Network Solutions

Löhbacher Str. 7 | 58553 Halver | 02353 7007 0 | +49 2353 7007 0

manhattan-products.com | intellinet-network.com

Sound that stays with you

Wireless Speakers
& Headphones



 **manhattan**[®]
Life just got easier.[™]